

ΕΞΑΕΡΙΣΤΗΡΕΣ ΑΕΡΑΓΩΓΩΝ ΑΘΟΥΡΒΟΙ ΣΕΙΡΑ TD SILENT

IN LINE SILENT FANS

- 230V/50Hz 2 ταχυτήτων
- Προστασία μοτέρ IP: 44 κλάση Β. Θερμικό προστασίας
- Με διπλό ηχομονωμένο κέλυφος

i Παγκοσμίως ο πιο αθόρυβος εξαεριστήρας στην κατηγορία του

ΕΦΑΡΜΟΓΕΣ: Σε κάθε εγκατάσταση που απαιτείται χαμηλή στάθμη θορύβου

ΡΥΘΜΙΣΗ: Με διακόπτη 2 ταχυτήτων COM-2 ή REGUL -2 ή ροοστατικά με REB-2,5.

ΚΑΤΟΠΙΝ ΑΠΑΙΤΗΣΕΩΣ: Διατίθενται και τύποι με χρονοκαθυστέρηση.



Ο πιο αθόρυβος εξαεριστήρας του κόσμου στην κατηγορία του!



Καμπύλες απόδοσης στις τεχνικές σελίδες του καταλόγου.

ΤΥΠΟΣ	ΣΤΡΟΦΕΣ rpm	MAXIMUM WATT	MAXIMUM AMBER	ΠΑΡΟΧΗ ΑΕΡΑ m ³ /h	ΘΕΡΜΟΚΡ. ΛΕΙΤΟΥΡΓΙΑΣ °C	dB (A)	ΔΙΑΜΕΤΡΟΣ Ømm	ΒΑΡΟΣ kg	ΤΙΜΗ €
TD-160/100 SILENT	2500	20	0,16	180	-20/+40	24	100	1,40	
	2200	12	0,10	140		21			
TD-250/100 SILENT	2200	24	0,11	240	-20/+40	24	100	5,40	
	1850	18	0,10	180		19			
TD-350/125 SILENT	2250	30	0,13	380	-20/+40	20	125	4,94	
	1900	22	0,10	280		19			
TD-500/150-SILENT	2500	50	0,22	580	-20/+60	22	150	6,00	
TD-500/160-SILENT	1950	44	0,19	430		17	160		
TD-800/200 SILENT	2780	70	0,30	880	-20/+60	19	200	8,70	
	2480	60	0,26	700		18			
TD-1000/200 SILENT	2500	120	0,50	1100	-40/+60	21	200	8,70	
	2000	100	0,45	800		20			

ΕΦΑΡΜΟΓΕΣ

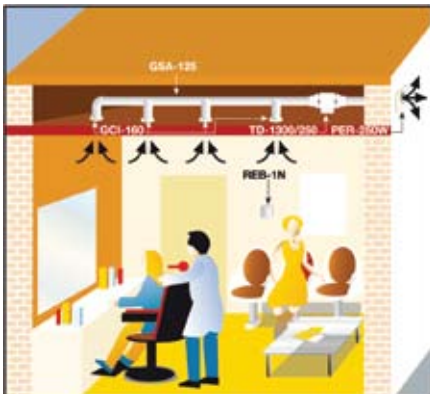

APPLICATIONS

ΕΞΑΕΡΙΣΤΗΡΕΣ ΑΕΡΑΓΩΓΩΝ ΑΘΟΥΡΒΟΙ ΣΕΙΡΑ TD 1300 & 2000

IN LINE SILENT FANS

- 230V/50Hz 2 ταχυτήτων
- Προστασία μοτέρ IP: 44 κλάση Β.
- Με θερμικό προστασίας
- Με διπλό ηχομονωμένο κέλυφος

ΡΥΘΜΙΣΗ: Με διακόπτη 2 ταχυτήτων COM-2 ή REGUL-2 ή ροοστατικά με REB-2,5.



ΤΥΠΟΣ	ΣΤΡΟΦΕΣ rpm	MAXIMUM WATT	MAXIMUM AMBER	ΠΑΡΟΧΗ ΑΕΡΑ m ³ /h	ΘΕΡΜΟΚΡ. ΛΕΙΤΟΥΡΓΙΑΣ °C	dB (A)	ΔΙΑΜΕΤΡΟΣ Ømm	ΒΑΡΟΣ kg	ΤΙΜΗ €
TD-1300/250 SILENT	2570 2190	197 145	0,83 0,61	1.270 1.070	-40/+60	35 31	250	20	
TD-2000/315 SILENT	2680 2300	297 191	1,28 0,79	1.760 1.500	-20/+60	39 33	315	25	

ΔΙΑΣΤΑΣΕΙΣ - ΚΑΜΠΥΛΕΣ

DIMENSIONS - CURVES

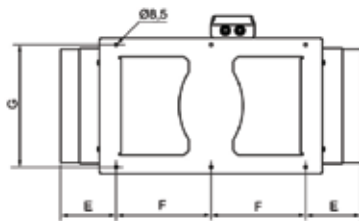

	A	B	C	D	E	F	G	H
TD-1300/250 SILENT	680	248	331	387	140	200	280	171
TD-2000/315 SILENT	825	312	373	432	152	260	335	192

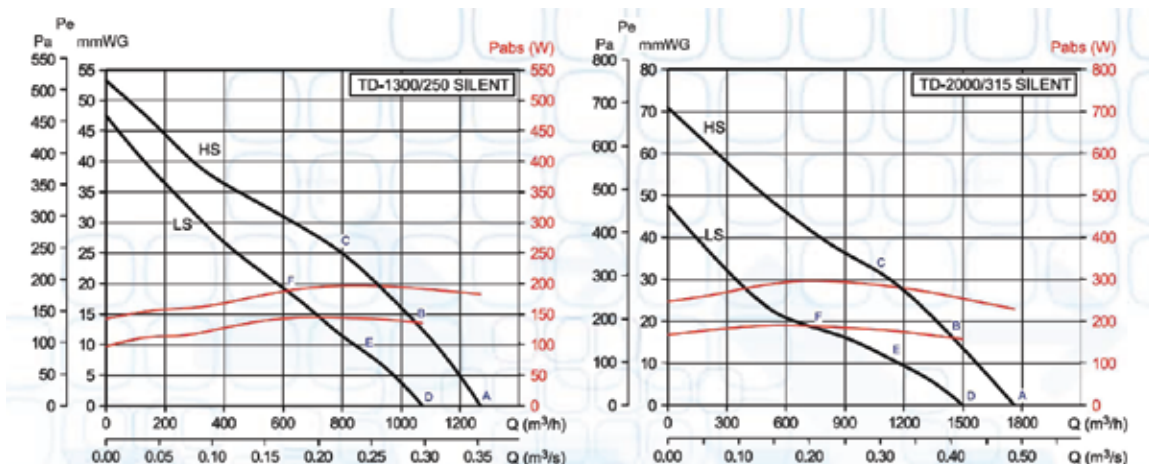
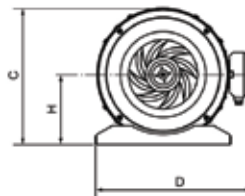
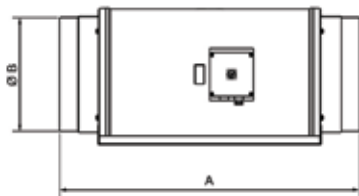

ΚΑΜΠΥΛΕΣ TD-SILENT

PERFORMANCE CURVES TD-SILENT

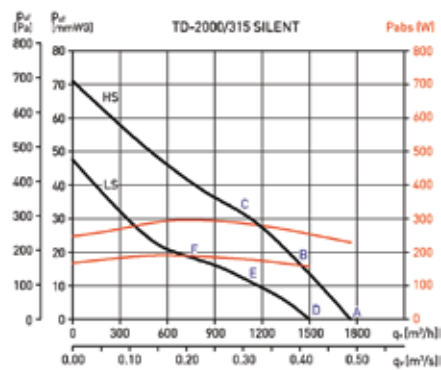
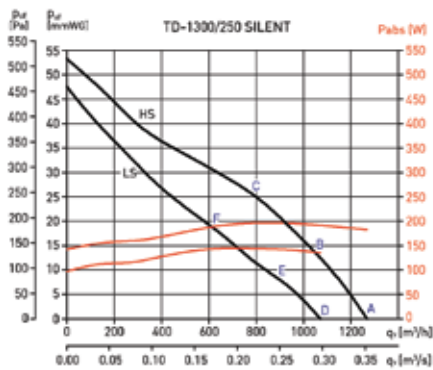
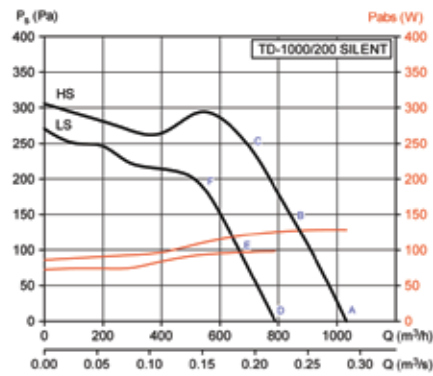
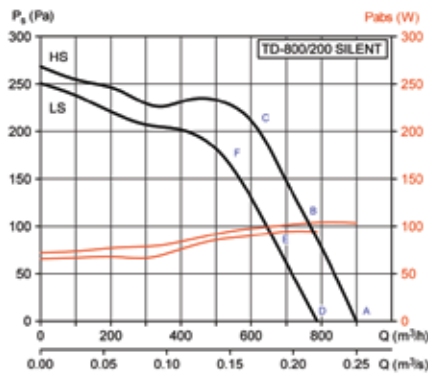
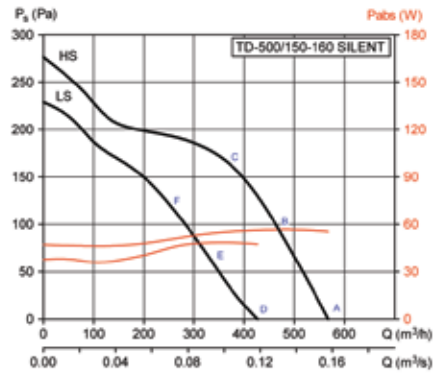
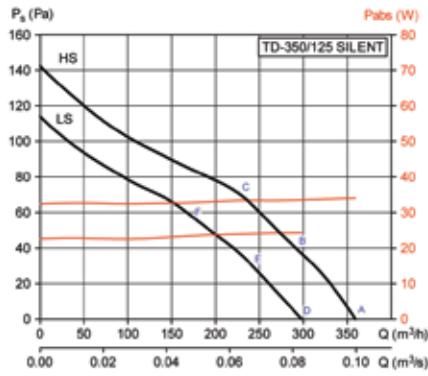
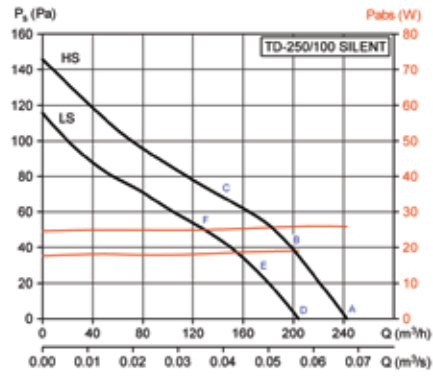
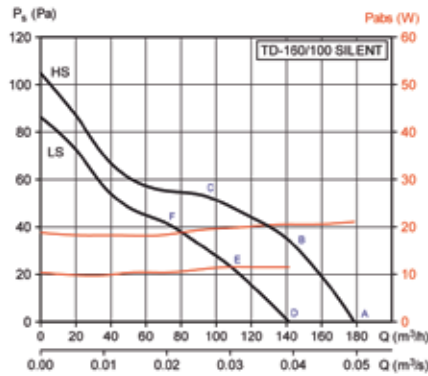

ΔΙΑΣΤΑΣΕΙΣ TD SILENT (mm)

DIMENSIONS TD SILENT

TD-160/100 N SILENT

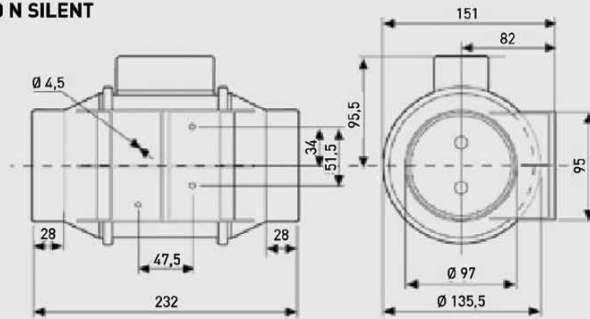

TD-SILENT 250 to 1000

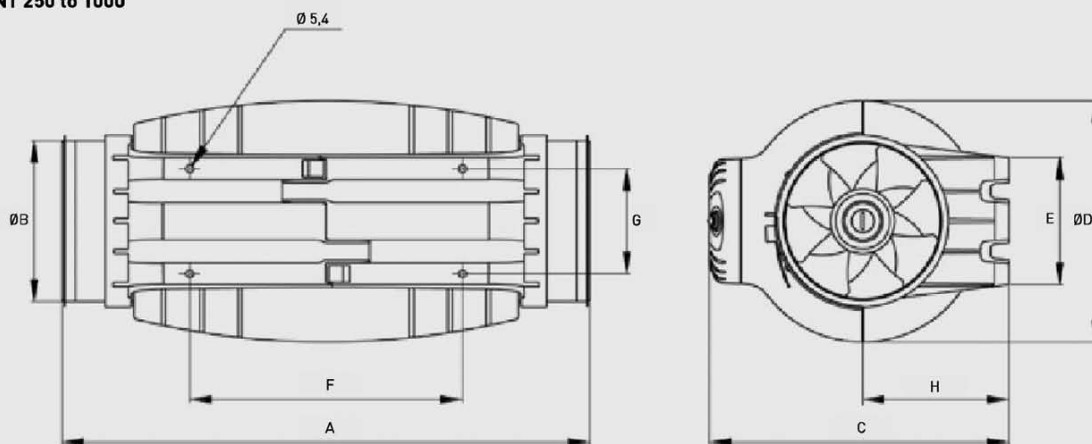

	A	ØB	C	ØD	E	F	G	H
TD-250/100	575	97	252	204	100	250	83	121
TD-350/125	462	123	252	204	100	250	83	121
TD-500/150-160*	484	147	274	221	116	250	96	134
TD-800/200	568	198	327	264	145	340	129	164
TD-1000/200	568	198	327	264	145	340	129	164

* It provides an additional rubber gasket for installation in 160 mm ducts.

TD-SILENT 1300 and 2000

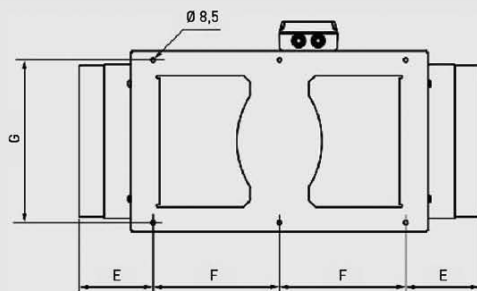

	A	B	C	D	E	F	G	H
TD-1300/250 SILENT	680	248	331	387	140	200	280	171
TD-2000/315 SILENT	825	312	373	432	152	260	335	192

