

Hygienic.

The hygiene concept deliberately does away with biocide and chemical disinfectants. Only demineralized water* without additives gets into the air you breathe.



The systems contain no porous or water storing components. Standing water is effectively eliminated and when stopped, the system is automatically emptied and checked at regular cycles in compliance with VDI 6022.

In the HPS and LPS models only inert materials come into contact with the humidification water and thanks to their material properties ensure hygienically safe and flawless humidification - a basic prerequisite in air conditioning.

Conserving resources.

HygroMatik's adiabatic humidification systems provide high humidification performance and low energy consumption. Thanks to their high efficiency and exact controllability, the systems provide a particularly efficient use of the demineralized water* employed.

Humidification with demineralized water* prevents scaling and guarantees low maintenance requirements.

HygroMatik systems means fast amortization and long service life by using high quality components.

Certified.

The HPS and LPS comply with German standards VDI 6022, 3803 and DIN 1946, the equivalent Austrian and Swiss standards and European Standard DIN EN 13779.

A recognized, independent testing laboratory has examined and confirmed conformity with the Directives and the recognized state of the art technology (VDE Test Report No. 802300-3980-0001/85569 for HPS, and VDE Test Report No. 802300-3980-002/141937 for LPS). The HPS and LPS are CE-certified and hold the hygiene conformity certificate for air conditioning and hospitals.

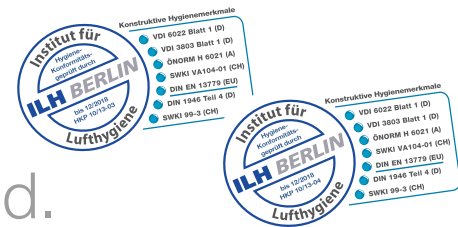

- Made only with inert materials
- Control system optimized for hygiene
- VDI 6022-compliant stand-by flushing

- Adjustment of flushing and idling parameters during commissioning
- Maintenance according to schedule - annually or every 2500 h
- Fast and long-term availability of spare parts
- Extensive service partner network
- Technical Hotline

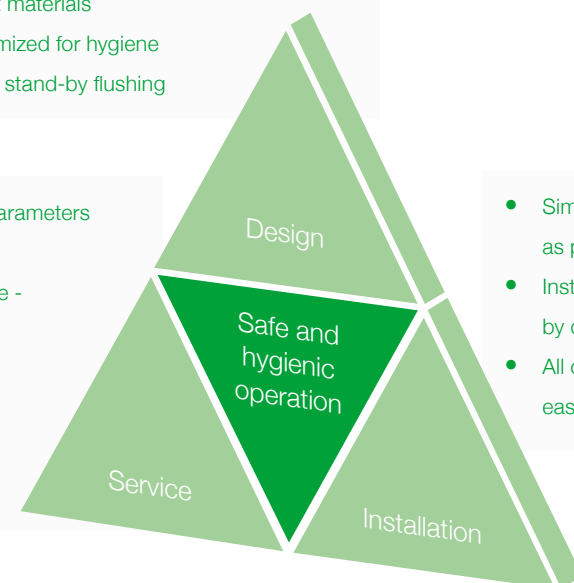

- Simple modular assembly as per VDI 6022 requirements
- Installation and commissioning by qualified staff
- All components are easy to clean

* Residual conductivity 5-20 µS/cm

Technical Data HPS

Type		250	500
Power rating	[kW]	0.94	1.6
Water capacity (75 bar)	[l/h]	46 – 260	90 – 520
Current connection	[A]	4.0	6.7
Voltage connection	[V/ph/Hz]	230/1/50	
Control signal *	[V/mA]	0 – 10 / 4 – 20	
Dimensions Vortex modules	[mm]	150 x 150	
Number of nozzles		6 – 39	18 – 104
Absorption distance (optimum)	[m]	0.9	
Overall installation length, min.	[m]	1.5	
Flow rate	[m/s]	0.9 – 2.8	
Pressure drop in duct	[Pa]	80 at 2.0 m/s air velocity	

Technical Data LPS

Type		45	72	110
Power rating	[kW]	0.15	0.16	0.18
Water capacity (16 bar)	[l/h]	4 – 56	10 – 90	20 – 130
Current connection	[A]	1.9	2.1	2.7
Voltage connection	[V/ph/Hz]	230/1/50		
Control signal *	[V/mA]	0 – 10 / 4 – 20		
Dimensions Vortex modules	[mm]	150 x 150		
Number of nozzles		15	22	32
Absorption distance (optimum)	[m]	0.9		
Overall installation length, min.	[m]	1.5		
Flow rate	[m/s]	0.9 – 2.8		
Pressure drop in duct	[Pa]	80 at 2.0 m/s air velocity		

* Other control signals on request
Subject to technical amendments without notice



HygroMATIK
WE HUMIDIFY THE AIR

HygroMatik GmbH
Lise-Meitner-Str. 3
24558 Henstedt-Ulzburg
Germany

T +49 4193 895-0
F +49 4193 895-33
hy@hygromatik.de
www.hygromatik.com

A member of the **spiral/sarco** group



HygroMATIK
WE HUMIDIFY THE AIR

HPS and LPS

Adiabatic High and Low Pressure Systems



HygroMATIK
MORE THAN
45 YEARS
HUMIDIFICATION



Humidifying and Cooling.



Adiabatic.

The adiabatic HPS and LPS, high and low pressure nozzle systems by HygroMatik, humidify the air in air conditioning and ventilation systems with demineralized water and offer very high humidification with particularly low energy consumption and high control accuracy.

High and low pressure atomization makes for an optimum spray pattern with minimum energy consumption. The evaporation of the fine mist cools the air adiabatically. When cooling exhaust air in the summer, this can save up to 1/3 of the cooling capacity in the design of your cooling coil.

Dry.

High-precision, stainless steel nozzles produce a very fine mist which is rapidly absorbed into the air in the humidification chamber. With their varying spray angles and the production of optimal droplet sizes, they ensure almost completely dry walls in the humidification chamber.

Furthermore, the Vortex wall assembled from specially developed Vortex modules mixes air and water mist effectively and over a very short absorption distance. The rapid and efficient absorption takes place with virtually no loss of water - yet another saving. Due to its optimal efficiency, the system provides extremely short absorption distances.

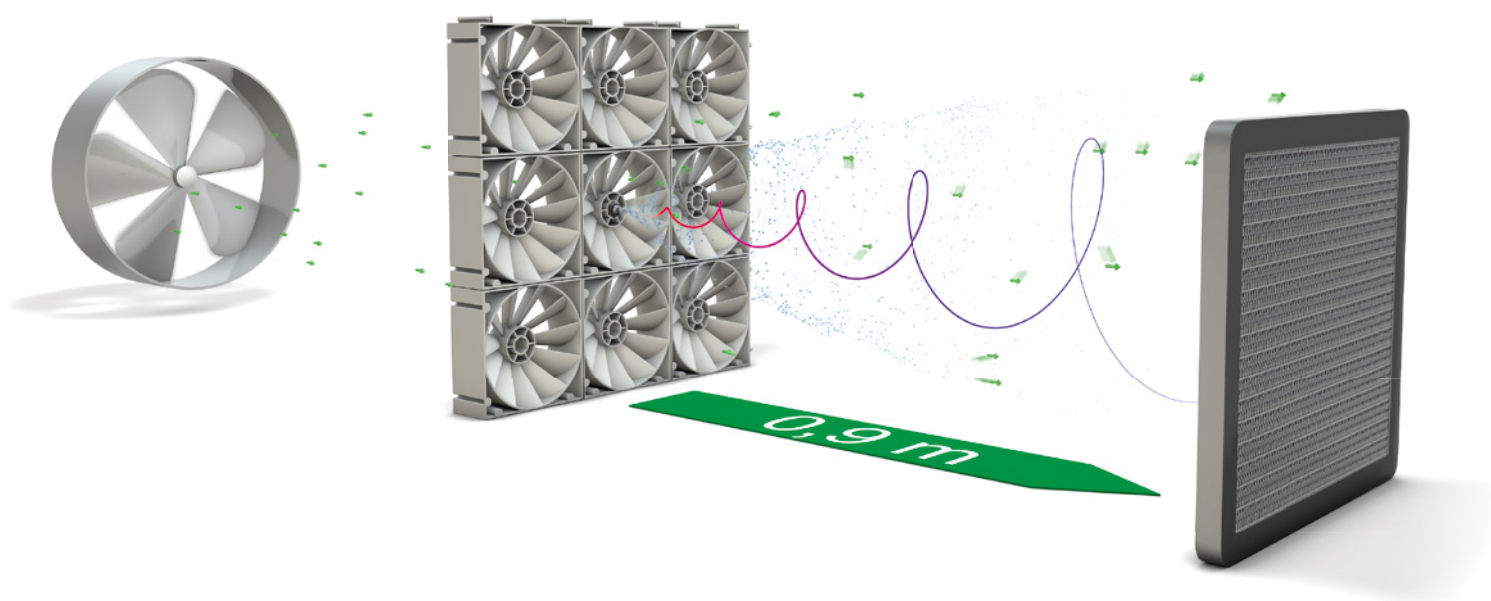

Perfectly adjustable and safe.

Thanks to their modular construction, the HPS and LPS systems are suitable for any air duct. The high-quality control system offers the most precise control of proportional humidification. Continuous monitoring of all system components and functions ensures maximum operating safety. It goes without saying that operating and fault signals are integrated into your central building control system.



HPS



LPS

HPS

High Pressure Nozzle System

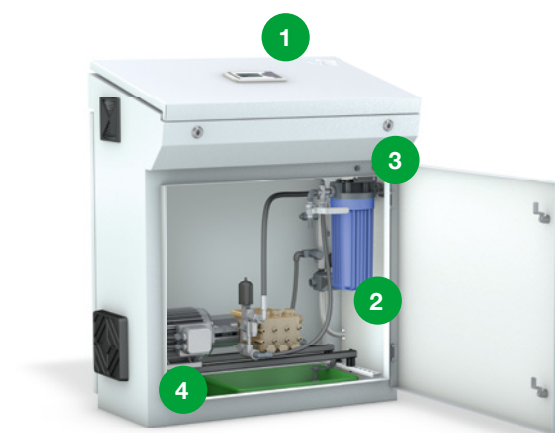

1. Operation
2. Water supply
3. Water distribution
4. Pump station

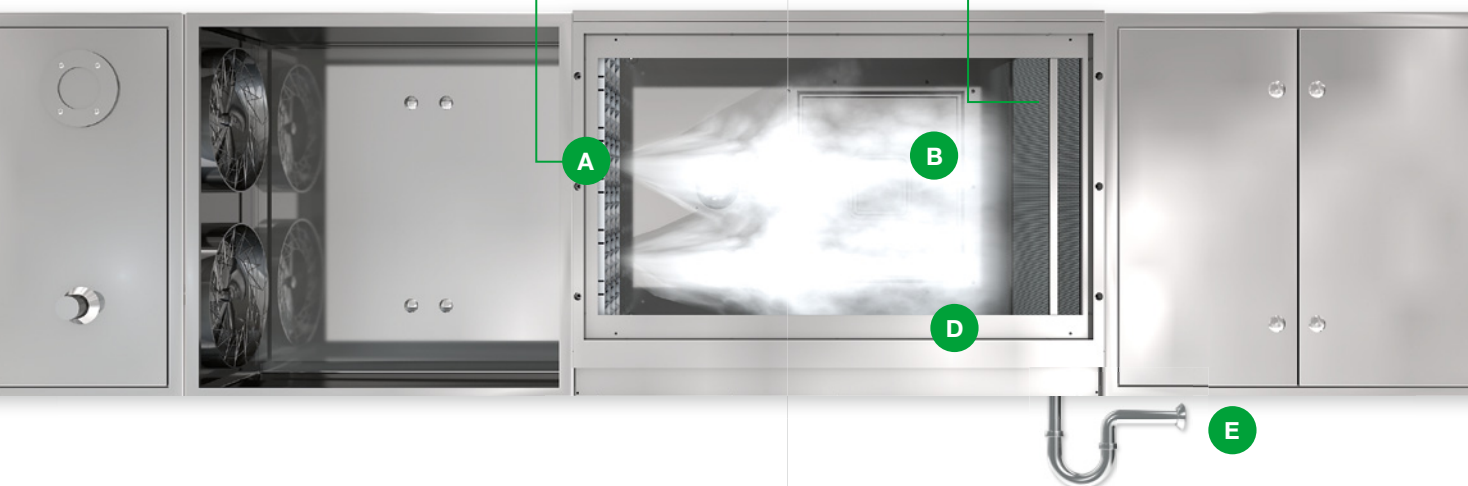
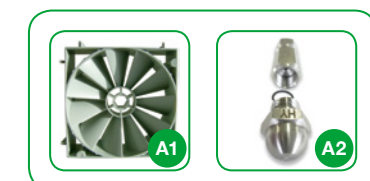

- A. Vortex module wall
- A1. Vortex module
- A2. Nozzle
- B. Dimmable inspection window (required as per German VDI 6022)
- C. 2-stage droplet separator

LPS

Low Pressure Nozzle System

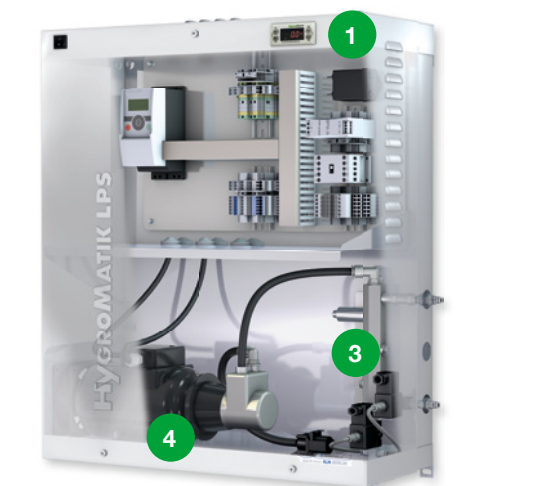

1. Operation
2. Water supply
3. Water distribution
4. Pump station



Equipment features at a glance

HPS

- Humidification capacity from 46-500 l
- Up to 18% higher efficiency at a humidification capacity of 46-130 l
- Up to 98% efficiency
- Graphic display shows all messages and operating data
- Easy menu navigation for setting relevant operating parameters
- Leakage protection by means of level regulation in the water pan
- Pump temperature monitoring
- Water sampling tap

LPS

- Humidification capacity from 4-110 l
- Up to 80% efficiency
- The water lubricated pump runs cleanly and safely without oil and provides maintenance-free operation for up to 2 years or 8,500 operation hours – depending on what comes first
- Small and compact
- Low noise

Features common to both models

- The systems are easy to install. The straightforward set-up provides easy and timesaving installation and commissioning for the technician
- The systems are also ideal for retrofitting in air conditioning ducts and scrubber chambers
- Low power consumption combined with extremely low maintenance requirements