

CC Version

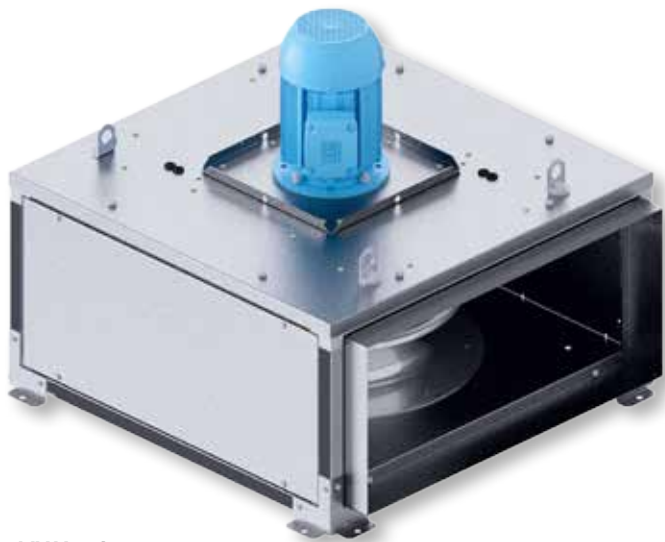

MV Version

Application

Smoke and hot gas extraction in case of fire.
 Extraction of stale air from commercial and industrial premises.
 Extraction of pollutants in professional kitchens.
 Installation in all positions and connection on all faces.
 Air stream temperature up to 120°C in continuous with motor at 40°C max. ambient air.

Range

8 sizes: 355, 400, 450, 500, 560, 630, 710 and 800
 Air performance range from 500 up to 23.000 m³/h.

ILHT CC: Fan with multidirectional inlet plenum, motor shaft horizontal or vertical.

ILHT MV: Ventilation unit only, motor shaft horizontal or vertical.

Construction

- Panels made of galvanized sheet steel.
- Modular structure in aluminum profiles.
- 4 mounting brackets.
- Rectangular duct couplings.
- Direct drive centrifugal backward curved impeller manufactured from galvanized sheet steel.
- Full access for cleaning and maintenance without dismantling the fan from the duct system.
- Motor are IP55, class F insulation and singlephase 230V 50Hz speed controllable by tension or three-phase 230/400V 50Hz, speed controllable by frequency inverter.

On request:

- For kitchen applications:
- Reinforced sealing with grease resistant seal.
 - Condensation drain provided not mounted.
- Two-speed motors (not ErP compliant).

Specific applications



Officially approved to EN12101-3



Continuous operation



Car parks



Commercial and industrial kitchens

TECHNICAL CHARACTERISTICS - CC VERSION

Before installation check that the product electrical characteristics listed on the data plate label (voltage, power, frequency, etc.) match those of the intended electrical supply.

Model type	Speed (rpm)	Motor power (W)	Nominal current (A) 230V	Maximum air volume (m³/h)	Sound pressure level* (dB(A))			Weight (kg)	Speed controller	
					Inlet	Radiated	Outlet		REB	RMB
SINGLE-PHASE 4 POLE MOTORS										
ILHB/4-355 CC	1340	0,25	2,5	3.140	56	49	62	59	5	3,5
ILHB/4-400 CC	1360	0,55	3,9	5.020	60	52	66	72	5	5
SINGLE-PHASE 6 POLE MOTORS										
ILHB/6-355 CC	900	0,18	1,6	2.110	48	41	54	59	2,5	3,5
ILHB/6-400 CC	890	0,25	2,3	3.280	51	43	57	72	5	3,5
ILHB/6-450 CC	890	0,25	2,3	4.750	56	49	62	92	5	3,5
ILHB/6-500 CC	860	0,37	3,0	5.660	57	48	64	114	5	3,5

Model type	Speed (rpm)	Motor power (W)	Nominal current (A)		Maximum air volume (m³/h)	Sound pressure level* (dB(A))			Weight (kg)	Frequency inverter			
			230V	400V		Inlet	Radiated	Outlet		VFKB		VFTM	
										MONO	TRI	MONO	TRI
THREE-PHASE 4 POLE MOTORS													
ILHT/4-355 CC	1410	0,25	1,4	0,8	3.370	57	50	63	59	24	45	0,37	0,37
ILHT/4-400 CC	1430	0,55	2,5	1,4	5.340	61	53	67	72	24	45	0,37	0,55
ILHT/4-450 CC	1460	1,1	4,1	2,3	7.860	66	59	72	92	24	45	0,75	1,1
ILHT/4-500 CC	1450	1,5	5,5	3,2	9.630	67	59	75	114	27	45	1,1	1,5
ILHT/4-560 CC	1440	2,2	7,9	4,6	12.470	69	58	72	159	27	48	2,2	2,2
THREE-PHASE 6 POLE MOTORS													
ILHT/6-355 CC	900	0,18	1,3	0,7	2.110	48	41	54	59	24	45	0,18	0,37
ILHT/6-400 CC	930	0,37	2,0	1,1	3.410	52	44	58	72	24	45	0,37	0,37
ILHT/6-450 CC	930	0,37	2,0	1,1	4.940	57	50	63	92	24	45	0,37	0,37
ILHT/6-500 CC	930	0,55	2,8	1,6	6.090	59	50	66	114	24	45	0,37	0,55
ILHT/6-560 CC	930	0,75	3,4	1,9	7.960	60	49	63	159	24	45	0,55	0,75
ILHT/6-630 CC	930	1,1	4,7	2,7	11.800	64	54	68	162	27	45	1,1	1,1
ILHT/6-710 CC	980	3	12,0	6,9	18.910	68	61	74	264	-	48	-	4
ILHT/6-800 CC	970	4	15,6	9,0	25.660	70	61	72	307	-	-	-	5,5

* sound pressure level measured in free field condition, at 1,5m

DIMENSIONS (mm)

Mounting with the motor in horizontal position.

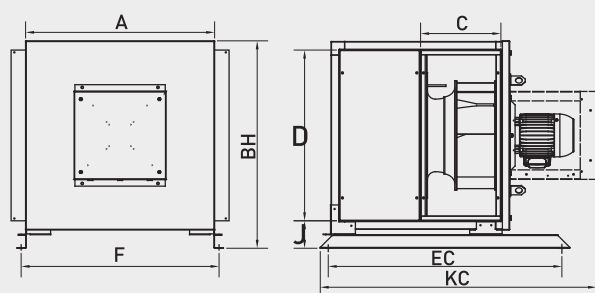

Mounting with the motor in vertical position.

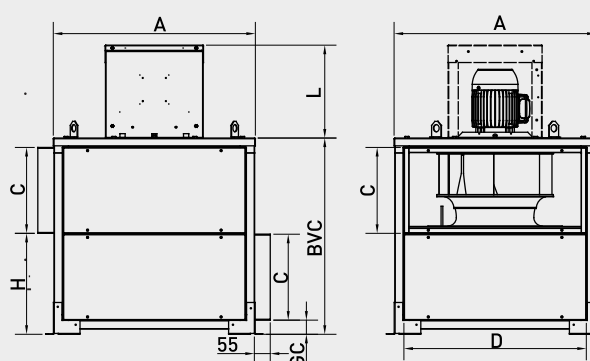

CC Model	A	BH	BVC	C	D	EC	F	GC	H	J	KC	L
355	627	695	645	263	559	790	660	50	315	102	954	321
400	699	767	678	297	631	864	732	50	349	102	1022	321
450	779	847	738	326	711	990	812	50	378	102	1081	321
500	858	925	784	338	768	1039	890	62	402	112	1145	351
560	954	1021	817	354	864	1139	986	62	419	112	1178	351
630	1066	1133	912	403	977	1183	1098	62	466	112	1273	351
710	1194	1261	1032	462	1104	1325	1226	62	526	112	1488	446
800	1338	1420	1084	488	1248	1379	1370	62	552	112	1540	446

TECHNICAL CHARACTERISTICS - MV VERSION

Before installation check that the product electrical characteristics listed on the data plate label (voltage, power, frequency, etc.) match those of the intended electrical supply.

Model type	Speed (rpm)	Motor power (W)	Nominal current (A) 230V	Maximum air volume (m³/h)	Sound pressure level* (dB(A))			Weight (kg)	Speed controller	
					Inlet	Radiated	Outlet		REB	RMB
SINGLE-PHASE 4 POLE MOTORS										
ILHB/4-355 MV	1340	0,25	2,5	3.310	56	45	57	39	5	3,5
ILHB/4-400 MV	1360	0,55	3,9	5.290	61	49	62	49	5	5
SINGLE-PHASE 6 POLE MOTORS										
ILHB/6-355 MV	900	0,18	1,6	2.220	48	37	50	39	2,5	3,5
ILHB/6-400 MV	890	0,25	2,3	3.460	52	40	53	49	5	3,5
ILHB/6-450 MV	890	0,25	2,3	5.040	56	45	58	67	5	3,5
ILHB/6-500 MV	860	0,37	3,0	5.950	57	47	59	88	5	3,5

Model type	Speed (rpm)	Motor power (W)	Nominal current (A)		Maximum air volume (m³/h)	Sound pressure level* (dB(A))			Weight (kg)	Frequency inverter			
			230V	400V		Inlet	Radiated	Outlet		VFKB		VFTM	
										MONO	TRI	MONO	TRI
THREE-PHASE 4 POLE MOTORS													
ILHT/4-355 MV	1410	0,25	1,4	0,8	3.550	57	46	59	39	24	45	0,37	0,37
ILHT/4-400 MV	1430	0,55	2,5	1,4	5.650	62	50	63	49	24	45	0,37	0,55
ILHT/4-450 MV	1450	1,1	4,1	2,3	8.320	66	55	67	67	24	45	0,75	1,1
ILHT/4-500 MV	1450	1,5	5,5	3,2	10.140	68	58	70	88	27	45	1,1	1,5
ILHT/4-560 MV	1450	2,2	7,9	4,6	12.900	69	58	72	111	27	48	2,2	2,2
THREE-PHASE 6 POLE MOTORS													
ILHT/6-355 MV	900	0,18	1,3	0,7	2.220	48	37	50	39	24	45	0,18	0,37
ILHT/6-400 MV	930	0,37	2,0	1,1	3.600	53	41	54	49	24	45	0,37	0,37
ILHT/6-450 MV	930	0,37	2,0	1,1	5.240	57	46	59	67	24	45	0,37	0,37
ILHT/6-500 MV	930	0,55	2,8	1,6	6.430	59	49	61	88	24	45	0,37	0,55
ILHT/6-560 MV	940	0,75	3,4	1,9	8.300	60	49	63	111	24	45	0,55	0,75
ILHT/6-630 MV	940	1,1	4,7	2,7	12.260	64	56	65	118	27	45	1,1	1,1
ILHT/6-710 MV	980	3	12,0	6,9	19.690	68	63	72	144	-	48	-	4
ILHT/6-800 MV	970	4	15,6	9,0	24.820	70	65	72	224	-	-	-	5,5

* sound pressure level measured in free field condition, at 1,5m

DIMENSIONS (mm)

Mounting with the motor in horizontal position.

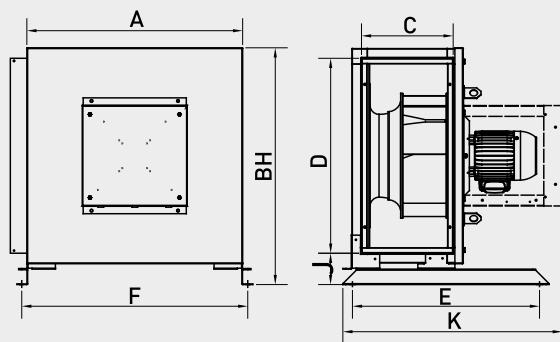

Mounting with the motor in vertical position.

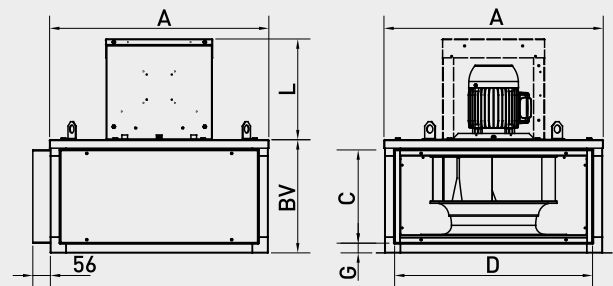

MV Model	A	BH	BV	C	D	E	F	G	J	K	L
355	627	695	327	263	559	606	660	31	102	677	321
400	699	767	361	297	631	606	732	31	102	711	321
450	779	847	392	326	711	606	812	31	102	743	321
500	858	925	424	338	768	700	890	42	112	805	351
560	954	1021	441	354	864	700	986	42	112	822	351
630	1066	1133	488	403	977	700	1098	42	112	869	351
710	1194	1261	551	462	1104	906	1226	42	112	994	446
800	1338	1420	574	488	1248	906	1370	42	112	1050	446

PERFORMANCE CURVES

- q_v : Airflow in m^3/h and m^3/s .
- p_{st} : Static pressure in mmWG and Pa.
- Dry air at 20°C and 760 mmHg.
- Performance data in accordance with ISO 5801 and AMCA 210-99 Standards.

ILHB/4-355 CC 0,25kW

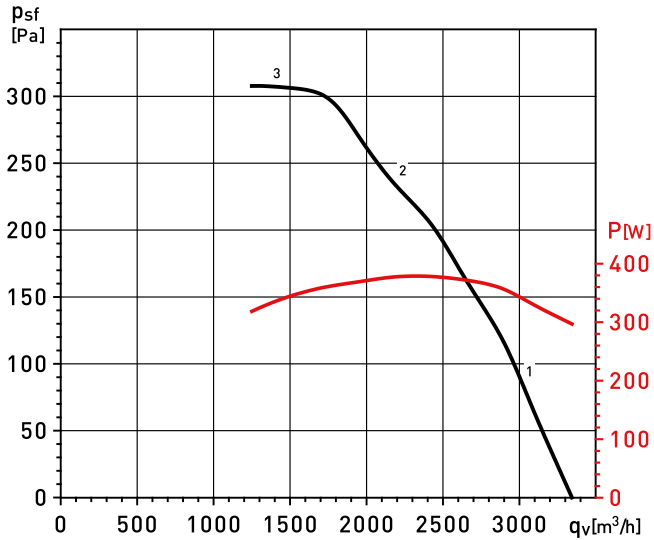

ILHB/4-355		63	125	250	500	1000	2000	4000	8000	LwA
INLET	1	48	69	64	65	67	66	62	53	74
	2	44	65	59	61	65	63	59	51	71
	3	52	62	58	61	61	60	55	48	68
OUTLET	1	45	73	71	70	73	70	65	58	79
	2	40	68	68	68	71	68	62	55	76
	3	48	65	67	67	68	64	57	51	74
RADIATED	1	45	58	55	52	57	54	50	43	63
	2	45	58	55	52	57	54	50	43	63
	3	53	56	54	51	53	51	46	40	61

ILHB/4-400 CC 0,55kW

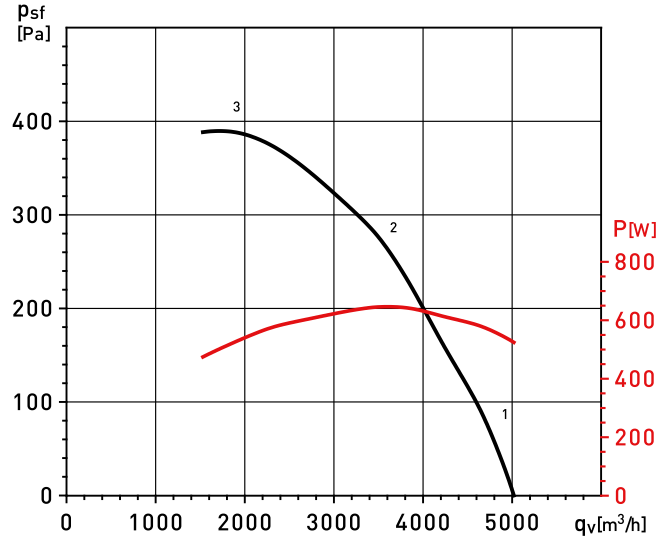

ILHB/4-400		63	125	250	500	1000	2000	4000	8000	LwA
INLET	1	55	71	69	70	71	72	67	59	78
	2	49	68	65	66	67	69	63	56	74
	3	55	66	62	65	66	65	60	55	72
OUTLET	1	52	75	78	78	80	76	72	65	85
	2	47	72	73	73	75	72	68	61	81
	3	53	69	72	72	74	69	62	56	79
RADIATED	1	53	64	66	60	62	64	57	50	71
	2	47	60	61	55	58	60	54	48	67
	3	53	58	58	55	57	57	50	47	64

ILHB/6-355 CC 0,18kW

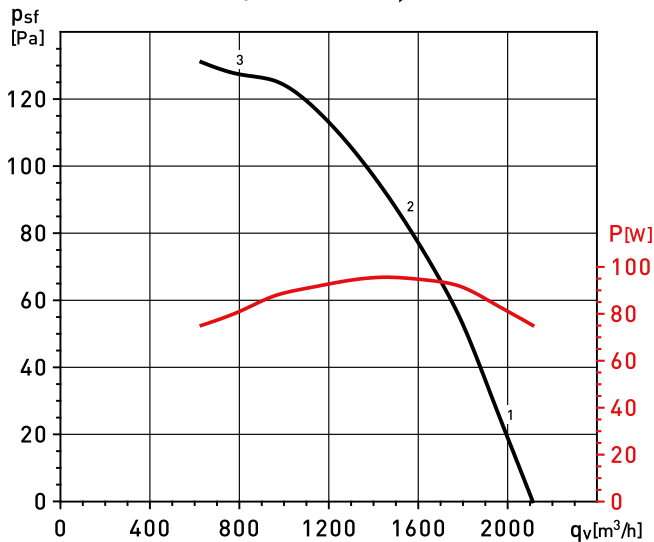

ILHB/6-355		63	125	250	500	1000	2000	4000	8000	LwA
INLET	1	41	61	56	57	59	58	54	45	66
	2	37	57	51	54	57	56	51	43	63
	3	44	54	50	53	54	52	47	40	60
OUTLET	1	37	65	64	63	66	63	58	50	71
	2	33	61	60	60	64	60	54	47	68
	3	40	58	60	59	61	57	50	43	66
RADIATED	1	41	55	52	48	51	49	45	37	59
	2	37	51	47	44	49	47	42	35	55
	3	45	48	46	43	45	43	39	32	53

ILHB/6-400 CC 0,25kW

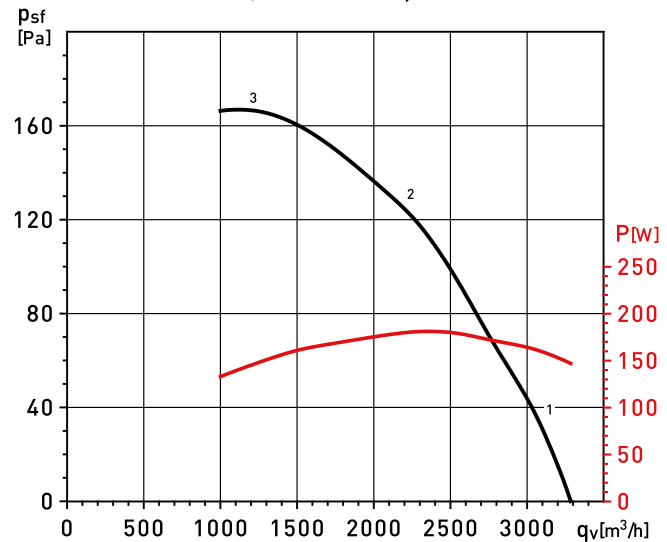

ILHB/6-400		63	125	250	500	1000	2000	4000	8000	LwA
INLET	1	47	63	61	62	63	63	58	50	70
	2	40	59	56	57	59	60	55	48	66
	3	46	57	53	57	57	56	51	47	64
OUTLET	1	43	67	70	69	71	68	63	56	76
	2	39	63	65	64	66	64	59	52	72
	3	44	60	64	63	65	60	53	47	70
RADIATED	1	44	55	57	51	53	55	49	42	62
	2	38	51	52	46	50	51	45	39	58
	3	44	49	49	46	48	48	42	38	56

PERFORMANCE CURVES

- q_v : Airflow in m^3/h and m^3/s .
- p_{st} : Static pressure in mmWG and Pa.
- Dry air at 20°C and 760 mmHg.
- Performance data in accordance with ISO 5801 and AMCA 210-99 Standards.

ILHB/6-450 CC 0,25kW

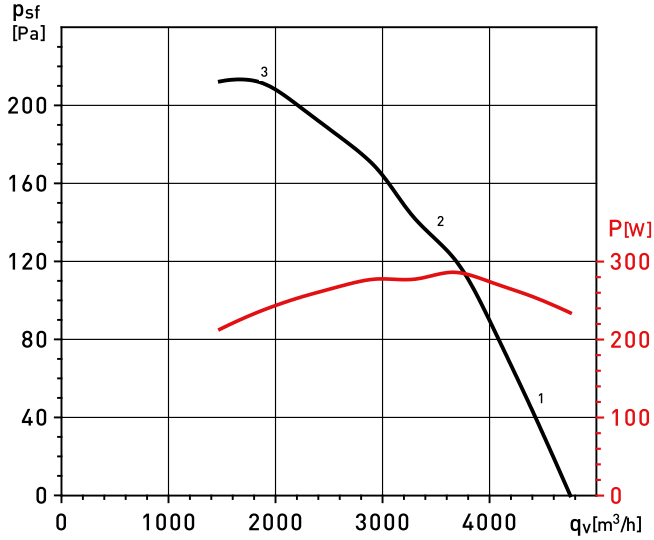

ILHB/6-450		63	125	250	500	1000	2000	4000	8000	LwA
INLET	1	50	66	66	66	66	67	62	56	74
	2	46	60	63	63	64	64	59	54	71
	3	50	60	60	62	61	61	58	53	68
OUTLET	1	53	68	75	75	77	72	68	61	82
	2	48	64	70	70	72	68	62	56	77
	3	50	63	69	69	70	64	57	52	75
RADIATED	1	45	59	62	58	59	58	54	47	67
	2	41	53	59	55	57	55	51	45	64
	3	45	53	56	54	54	52	49	44	62

ILHB/6-500 CC 0,37kW

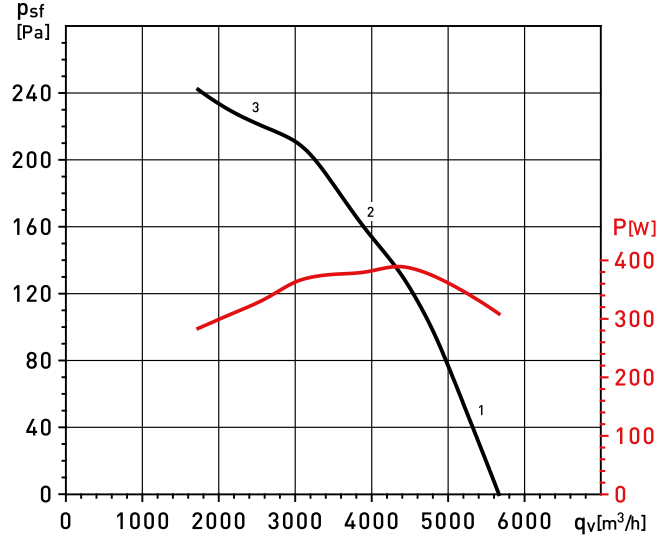

ILHB/6-500		63	125	250	500	1000	2000	4000	8000	LwA
INLET	1	54	63	66	67	69	68	63	57	74
	2	52	59	62	63	67	65	60	55	71
	3	55	61	60	62	64	62	57	51	70
OUTLET	1	56	71	77	77	79	73	69	62	83
	2	51	66	72	72	75	69	64	58	79
	3	53	65	70	70	72	65	60	53	76
RADIATED	1	43	53	58	55	62	56	51	44	66
	2	41	49	53	52	60	53	47	41	63
	3	44	50	52	51	58	50	44	38	61

ILHT/4-355 CC 0,25kW

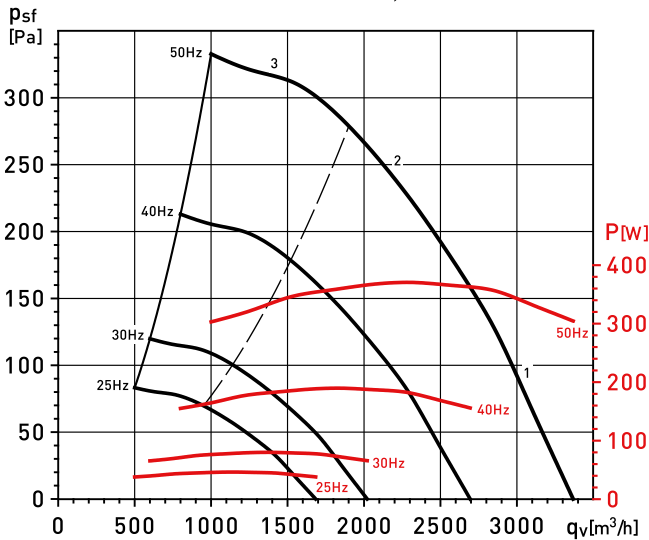

ILHT/4-355		63	125	250	500	1000	2000	4000	8000	LwA
INLET	1	50	70	65	66	68	67	63	54	75
	2	46	66	60	63	66	64	60	52	72
	3	53	63	59	62	63	61	56	49	69
OUTLET	1	46	74	73	72	74	72	67	59	80
	2	42	70	69	69	73	69	63	56	77
	3	49	66	68	68	70	65	59	52	75
RADIATED	1	46	59	56	53	58	56	51	44	64
	2	46	59	56	53	58	56	51	44	64
	3	54	57	55	52	54	52	47	41	62

ILHT/4-400 CC 0,55kW

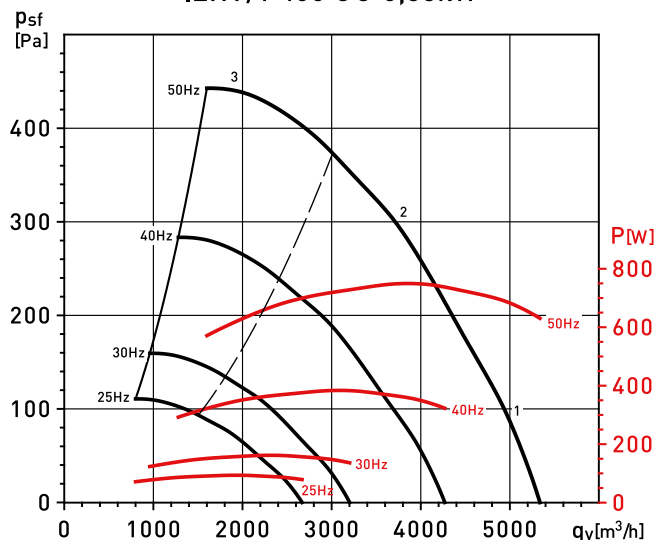

ILHT/4-400		63	125	250	500	1000	2000	4000	8000	LwA
INLET	1	57	72	71	72	72	73	68	60	79
	2	50	69	66	67	69	70	64	57	76
	3	56	67	63	66	67	66	61	56	73
OUTLET	1	53	76	80	79	81	77	73	66	86
	2	48	73	74	74	76	74	69	62	82
	3	54	70	73	73	75	70	63	57	80
RADIATED	1	54	65	67	61	63	65	58	51	72
	2	48	61	62	56	59	61	55	49	68
	3	54	59	59	56	58	58	51	48	66

PERFORMANCE CURVES

- q_v : Airflow in m^3/h and m^3/s .
- p_{sf} : Static pressure in mmWG and Pa.
- Dry air at 20°C and 760 mmHg.
- Performance data in accordance with ISO 5801 and AMCA 210-99 Standards.

ILHT/4-450 CC 1,1kW

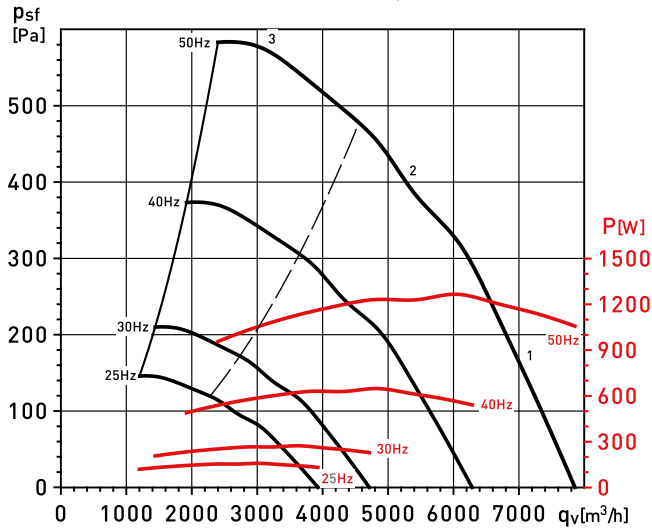

ILHT/4-450		63	125	250	500	1000	2000	4000	8000	LwA
INLET	1	60	76	75	76	76	76	72	65	83
	2	56	70	73	73	74	74	69	64	80
	3	60	70	70	72	71	71	67	63	78
OUTLET	1	62	78	85	85	87	82	78	71	91
	2	57	74	80	80	82	78	72	66	87
	3	60	72	78	78	80	74	67	61	84
RADIATED	1	55	69	71	68	69	68	64	57	76
	2	50	63	69	65	67	65	60	55	73
	3	54	63	66	64	64	62	59	54	71

ILHT/4-500 CC 1,5kW

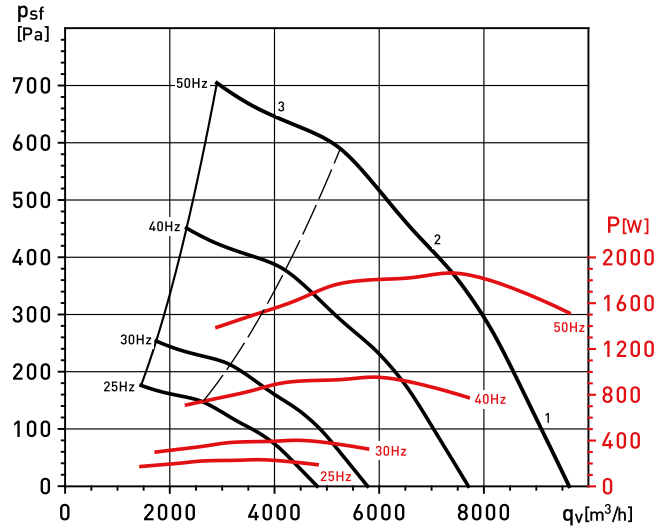

ILHT/4-500		63	125	250	500	1000	2000	4000	8000	LwA
INLET	LP	1	73	76	77	79	79	74	68	85
	MP	2	70	72	74	77	75	70	65	82
	HP	3	71	71	73	75	72	67	61	80
OUTLET	LP	1	81	88	87	90	84	80	72	94
	MP	2	76	82	82	86	79	75	68	89
	HP	3	75	81	80	83	76	70	63	87
RADIATED	LP	1	63	69	66	73	67	62	55	76
	MP	2	60	64	62	71	63	58	52	73
	HP	3	61	63	61	68	60	55	48	71

ILHT/4-560 CC 2,2kW

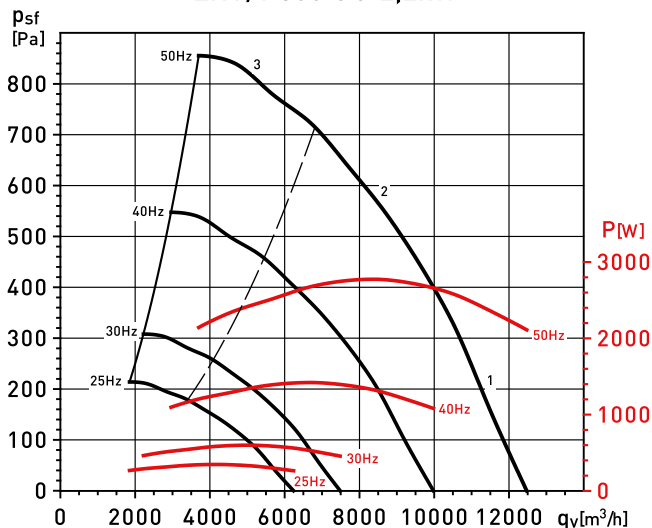

ILHT/4-560		63	125	250	500	1000	2000	4000	8000	LwA
INLET	1	58	76	75	73	80	78	75	69	85
	2	57	73	72	74	79	77	73	67	83
	3	63	79	75	74	78	74	70	65	84
OUTLET	1	60	81	82	80	83	80	78	73	89
	2	59	79	79	77	82	79	76	70	87
	3	63	79	80	78	81	77	73	67	86
RADIATED	1	47	66	67	64	69	66	62	55	74
	2	46	62	64	64	68	65	60	53	73
	3	52	68	67	65	67	62	57	51	73

PERFORMANCE CURVES

- q_v : Airflow in m^3/h and m^3/s .
- p_{st} : Static pressure in mmWG and Pa.
- Dry air at 20°C and 760 mmHg.
- Performance data in accordance with ISO 5801 and AMCA 210-99 Standards.

ILHT/6-355 CC 0,18kW

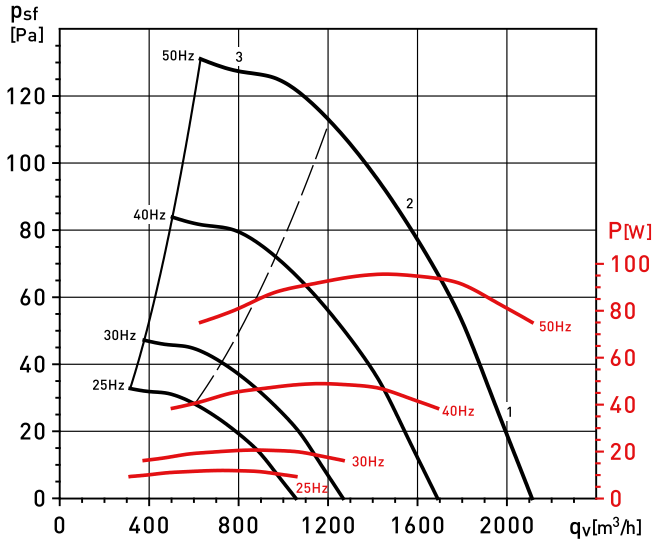

ILHT/6-355		63	125	250	500	1000	2000	4000	8000	LwA
INLET	1	41	61	56	57	59	58	54	45	66
	2	37	57	51	54	57	56	51	43	63
	3	44	54	50	53	54	52	47	40	60
OUTLET	1	37	65	64	63	66	63	58	50	71
	2	33	61	60	60	64	60	54	47	68
	3	40	58	60	59	61	57	50	43	66
RADIATED	1	41	55	52	48	51	49	45	37	59
	2	37	51	47	44	49	47	42	35	55
	3	45	48	46	43	45	43	39	32	53

ILHT/6-400 CC 0,37kW

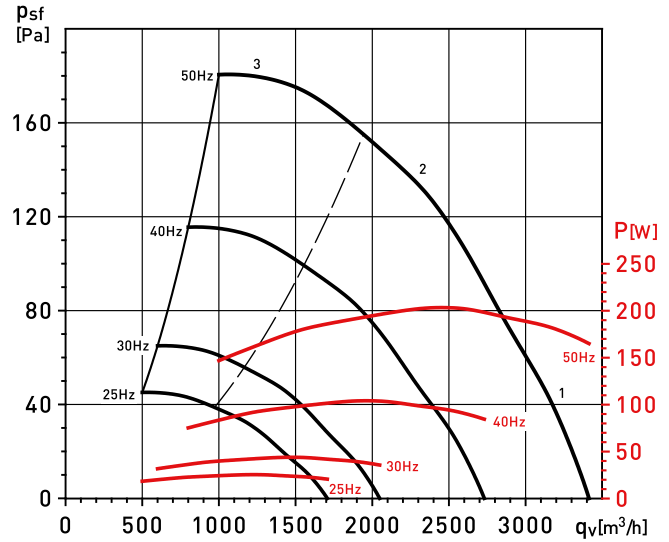

ILHT/6-400		63	125	250	500	1000	2000	4000	8000	LwA
INLET	1	48	64	62	63	64	64	59	51	71
	2	41	60	57	58	60	61	56	48	67
	3	47	58	54	58	58	57	52	48	65
OUTLET	1	44	68	71	70	72	69	64	57	77
	2	40	64	66	65	67	65	60	53	73
	3	45	61	65	64	66	61	54	48	71
RADIATED	1	45	56	58	52	54	56	50	43	63
	2	39	52	53	47	51	52	46	40	59
	3	45	50	50	47	49	49	43	39	57

ILHT/6-450 CC 0,37kW

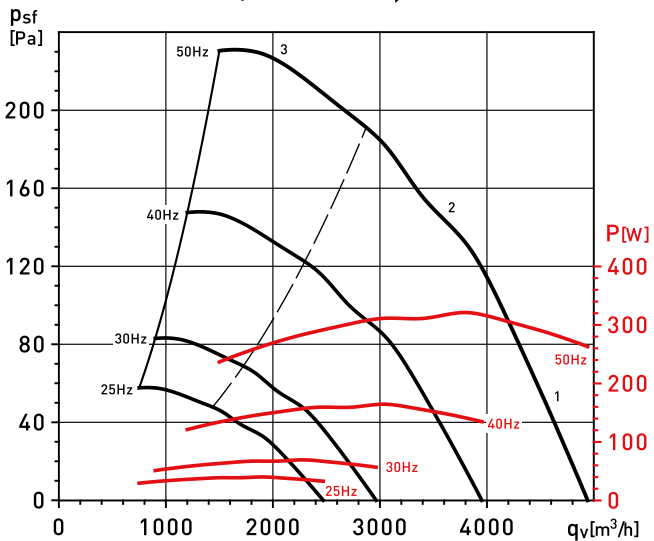

ILHT/6-450		63	125	250	500	1000	2000	4000	8000	LwA
INLET	1	51	67	67	67	67	68	63	57	74
	2	47	61	64	64	65	65	60	55	71
	3	51	61	61	63	62	62	59	54	69
OUTLET	1	53	69	76	76	78	73	69	62	82
	2	49	65	71	71	73	69	63	57	78
	3	51	64	70	70	71	65	58	52	76
RADIATED	1	46	60	63	59	60	59	55	48	68
	2	41	54	60	56	58	56	52	46	65
	3	46	54	57	55	55	53	50	45	62

ILHT/6-500 CC 0,55kW

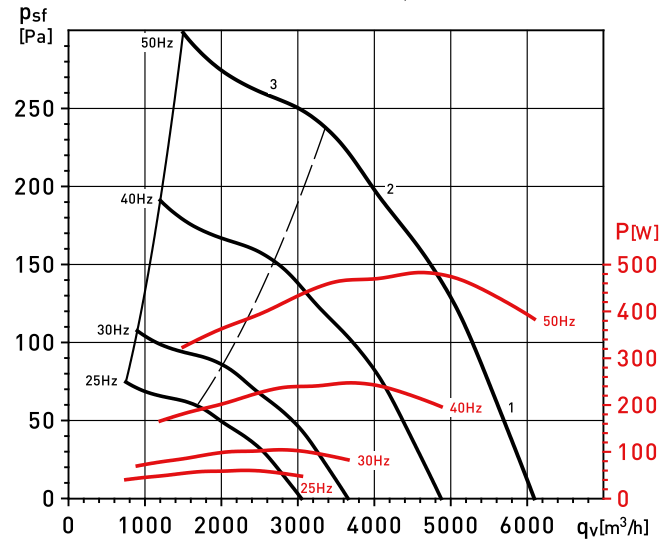

ILHT/6-500		63	125	250	500	1000	2000	4000	8000	LwA
INLET	1	55	64	68	68	70	70	65	59	76
	2	54	61	63	65	69	67	61	56	73
	3	56	62	62	64	66	64	58	53	71
OUTLET	1	57	72	79	78	81	75	71	63	85
	2	53	68	73	74	77	71	66	60	81
	3	55	66	72	72	74	67	61	54	78
RADIATED	1	45	55	60	57	64	58	53	46	67
	2	43	51	55	53	62	54	49	43	64
	3	46	52	54	52	59	51	46	40	62

PERFORMANCE CURVES

- q_v : Airflow in m^3/h and m^3/s .
- p_{st} : Static pressure in mmWG and Pa.
- Dry air at 20°C and 760 mmHg.
- Performance data in accordance with ISO 5801 and AMCA 210-99 Standards.

ILHT/6-560 CC 0,75kW

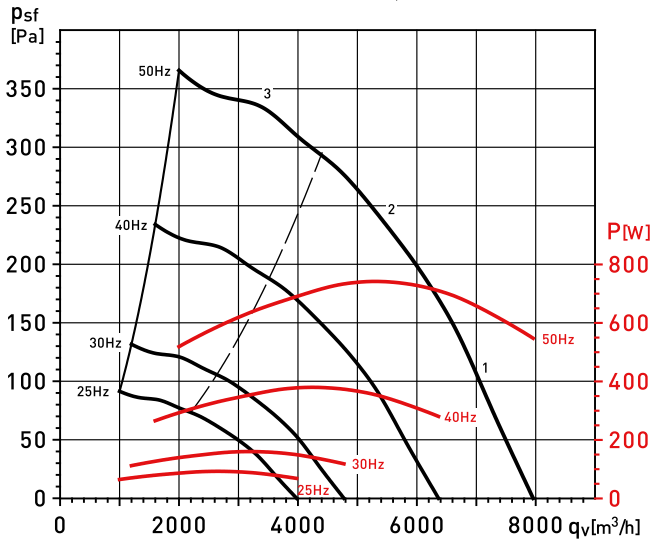

ILHT/6-560		63	125	250	500	1000	2000	4000	8000	LwA
INLET	1	49	68	66	64	71	70	66	61	76
	2	48	64	63	65	70	69	64	59	75
	3	55	70	66	65	69	66	61	57	75
OUTLET	1	51	72	73	71	74	71	69	64	80
	2	50	70	70	69	73	70	67	61	78
	3	54	70	71	69	72	68	64	58	78
RADIATED	1	38	57	59	55	60	58	53	46	65
	2	37	53	56	56	59	57	51	44	64
	3	43	59	58	56	58	54	48	42	65

ILHT/6-630 CC 1,5kW

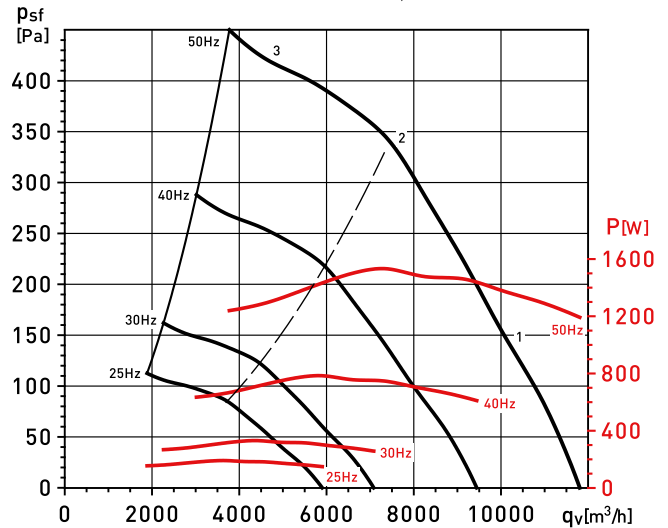

ILHT/6-630		63	125	250	500	1000	2000	4000	8000	LwA
INLET	1	64	72	75	74	77	74	69	62	82
	2	59	69	70	70	74	71	65	59	78
	3	63	67	69	69	72	67	62	57	77
OUTLET	1	64	76	78	80	81	76	71	64	86
	2	61	71	74	76	78	73	68	61	82
	3	64	71	75	75	76	70	64	58	81
RADIATED	1	57	68	64	63	66	64	57	51	73
	2	52	64	59	60	63	60	53	48	69
	3	57	63	59	59	61	56	50	46	68

ILHT/6-710 CC 3kW

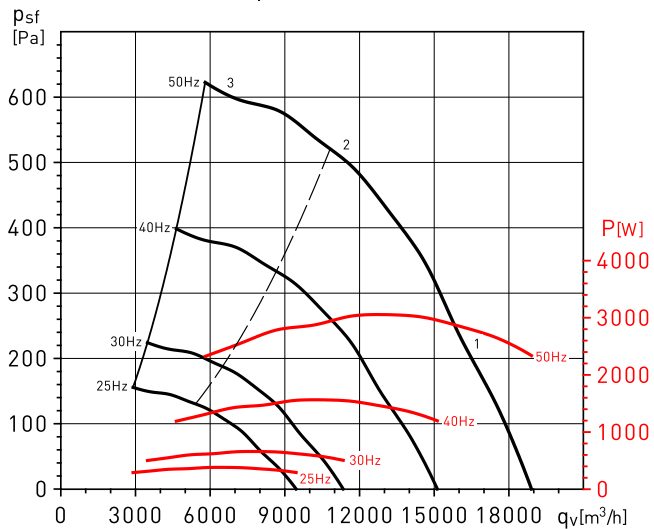

ILHT/6-710		63	125	250	500	1000	2000	4000	8000	LwA
INLET	1	70	76	77	78	80	76	69	64	85
	2	69	73	75	76	77	73	68	64	82
	3	70	70	74	75	76	72	68	65	81
OUTLET	1	70	85	86	89	89	82	75	68	94
	2	66	79	81	83	83	76	70	65	88
	3	70	78	81	83	81	74	68	63	87
RADIATED	1	59	72	69	74	70	63	54	48	78
	2	58	68	67	72	67	60	52	49	75
	3	59	66	66	71	66	59	53	49	74

ILHT/6-800 CC 4kW

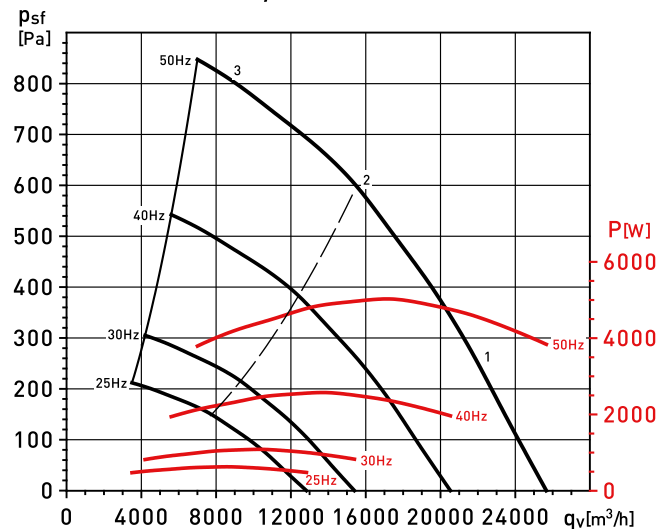

ILHT/6-800		63	125	250	500	1000	2000	4000	8000	LwA
INLET	1	59	75	73	75	80	78	72	67	85
	2	61	73	73	76	81	77	72	70	85
	3	70	76	75	75	77	73	71	67	83
OUTLET	1	68	85	85	88	88	85	78	75	93
	2	63	78	78	81	82	77	72	71	87
	3	69	78	79	80	80	76	72	69	86
RADIATED	1	51	68	64	62	70	69	64	67	75
	2	53	65	64	62	70	67	63	69	75
	3	61	68	65	61	66	62	61	65	74

PERFORMANCE CURVES

- q_v : Airflow in m^3/h and m^3/s .
- p_{st} : Static pressure in mmWG and Pa.
- Dry air at 20°C and 760 mmHg.
- Performance data in accordance with ISO 5801 and AMCA 210-99 Standards.

ILHB/4-355 MV 0,25kW

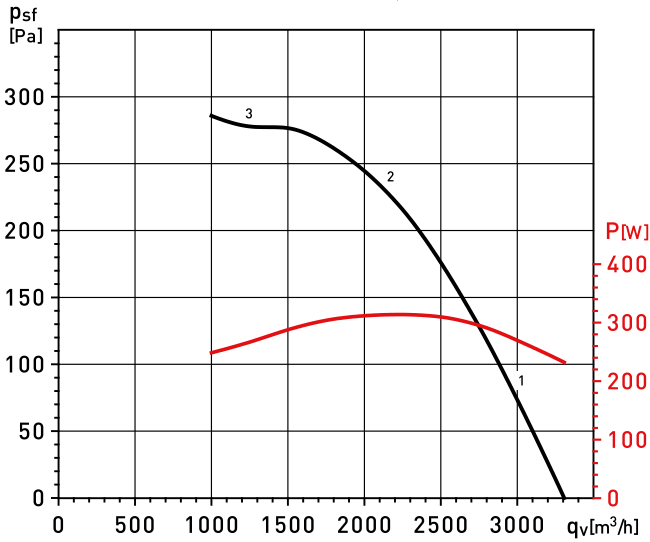

ILHB/4-355		63	125	250	500	1000	2000	4000	8000	LwA
INLET	1	41	66	64	60	65	66	63	58	72
	2	40	64	61	58	64	63	59	56	70
	3	50	65	64	60	64	60	56	51	70
OUTLET	1	41	65	68	66	67	68	64	58	75
	2	39	63	65	64	65	65	60	53	72
	3	50	64	67	65	65	62	56	50	72
RADIATED	1	40	51	48	48	53	53	50	49	59
	2	40	51	48	48	53	53	50	49	59
	3	51	52	51	50	52	51	47	44	59

ILHB/4-400 MV 0,55kW

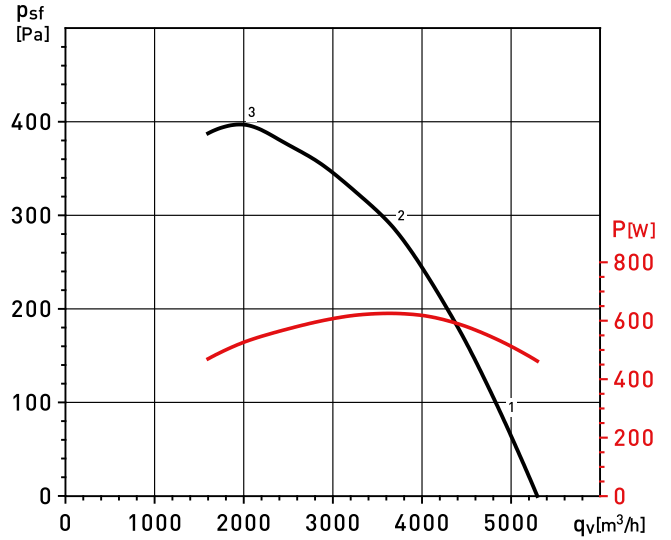

ILHB/4-400		63	125	250	500	1000	2000	4000	8000	LwA
INLET	1	45	75	71	65	69	71	67	63	79
	2	42	71	67	63	67	68	64	59	75
	3	53	71	68	64	66	66	62	57	75
OUTLET	1	47	70	72	72	74	73	69	63	80
	2	42	67	69	68	70	69	66	59	76
	3	54	69	71	69	70	67	61	54	76
RADIATED	1	42	62	60	55	58	58	53	47	67
	2	39	58	56	52	56	56	50	42	63
	3	50	58	57	54	55	53	48	41	63

ILHB/6-355 MV 0,18kW

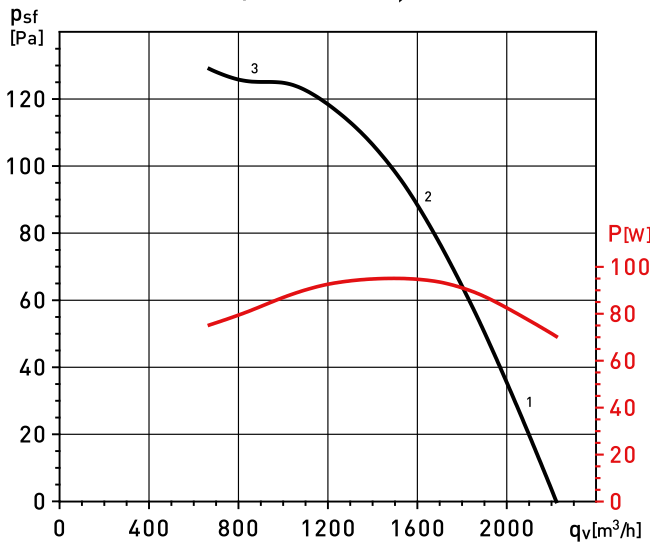

ILHB/6-355		63	125	250	500	1000	2000	4000	8000	LwA
INLET	1	33	59	56	52	57	59	55	50	65
	2	32	56	53	50	57	55	52	48	62
	3	43	57	56	52	56	52	48	44	63
OUTLET	1	33	58	60	58	60	60	56	50	67
	2	31	56	58	56	58	57	52	46	64
	3	42	57	59	58	57	55	48	42	64
RADIATED	1	34	46	44	43	46	49	46	43	54
	2	33	44	40	41	45	46	42	41	52
	3	43	45	44	43	44	43	39	37	52

ILHB/6-400 MV 0,25kW

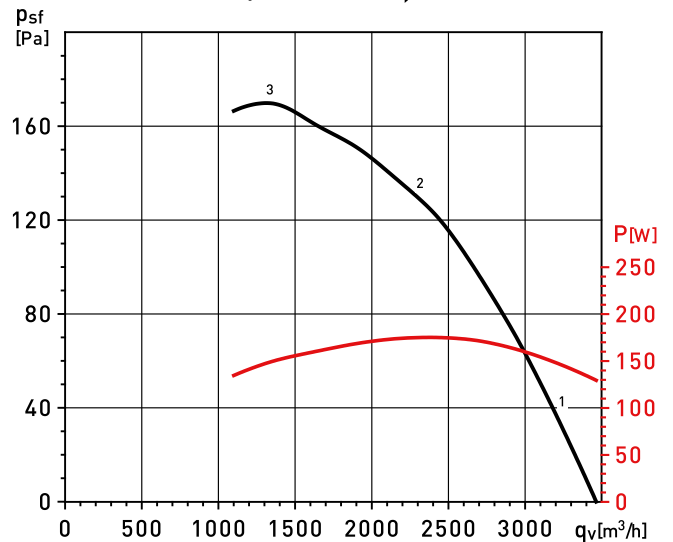

ILHB/6-400		63	125	250	500	1000	2000	4000	8000	LwA
INLET	1	37	67	63	57	60	62	58	55	70
	2	34	63	58	54	58	59	56	50	67
	3	44	62	60	55	58	57	53	49	66
OUTLET	1	38	61	64	63	65	64	61	55	71
	2	34	58	60	59	62	60	57	50	68
	3	45	60	62	60	62	58	52	45	68
RADIATED	1	33	54	51	46	49	50	45	38	58
	2	30	50	47	43	47	47	42	34	55
	3	41	49	49	45	47	45	39	32	54

PERFORMANCE CURVES

- q_v : Airflow in m^3/h and m^3/s .
- p_{sf} : Static pressure in mmWG and Pa.
- Dry air at 20°C and 760 mmHg.
- Performance data in accordance with ISO 5801 and AMCA 210-99 Standards.

ILHB/6-450 MV 0,25kW

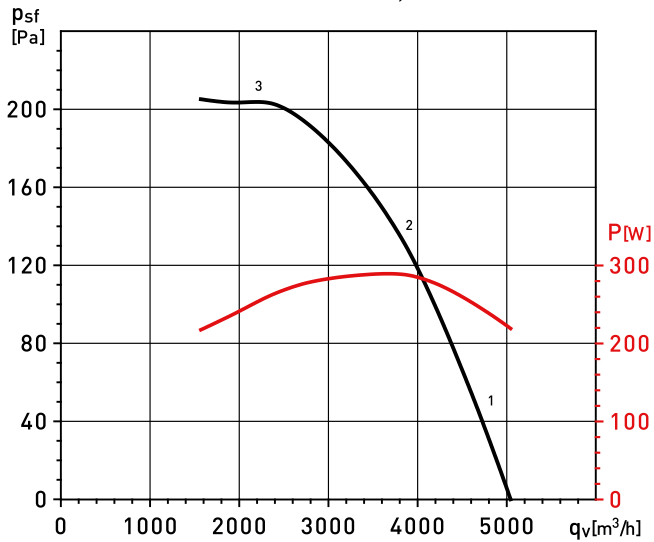

ILHB/6-450		63	125	250	500	1000	2000	4000	8000	LwA
INLET	1	43	67	64	60	66	65	62	57	73
	2	41	65	61	59	64	63	60	55	70
	3	52	65	63	61	63	60	56	51	70
OUTLET	1	43	66	68	67	69	67	64	59	75
	2	41	64	64	64	66	65	61	56	72
	3	48	64	66	65	66	62	57	51	72
RADIATED	1	40	58	53	49	54	54	52	44	62
	2	39	56	50	48	53	52	50	41	60
	3	49	56	51	49	52	49	46	37	60

ILHB/6-500 MV 0,37kW

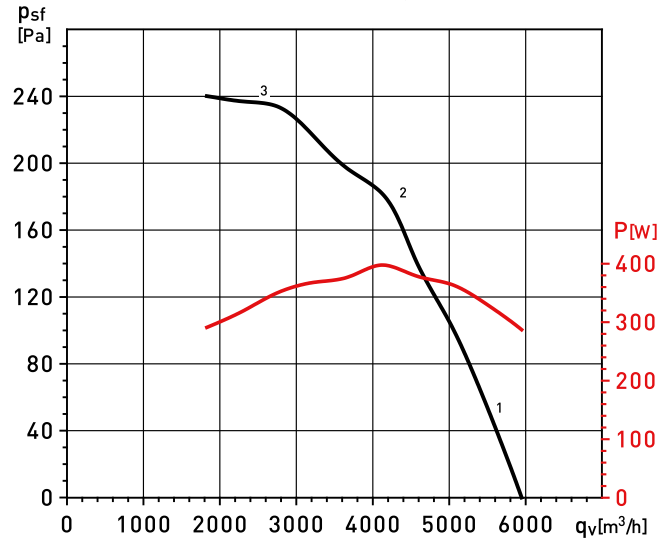

ILHB/6-500		63	125	250	500	1000	2000	4000	8000	LwA
INLET	1	47	64	62	62	68	67	65	60	73
	2	44	64	59	60	67	65	62	62	72
	3	47	65	60	61	66	64	62	59	71
OUTLET	1	48	67	69	67	71	68	65	61	76
	2	46	65	65	64	69	66	63	60	74
	3	49	65	67	65	68	64	61	56	74
RADIATED	1	39	54	55	53	57	56	54	48	63
	2	36	55	52	50	56	54	52	50	62
	3	38	55	53	51	55	53	52	48	61

ILHT/4-355 MV 0,25kW

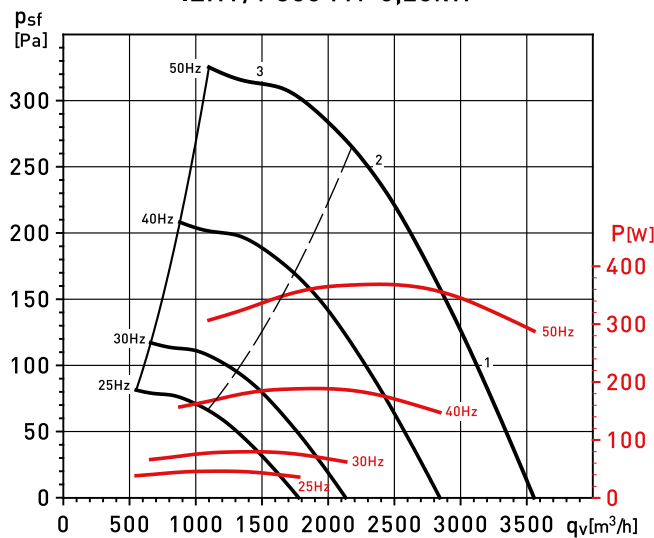

ILHT/4-355		63	125	250	500	1000	2000	4000	8000	LwA
INLET	1	42	67	65	61	66	67	64	59	74
	2	41	65	62	59	66	64	60	57	71
	3	52	66	65	61	65	61	57	52	71
OUTLET	1	42	67	69	67	69	69	65	59	76
	2	40	65	66	65	66	66	61	55	73
	3	51	66	68	66	66	64	57	51	73
RADIATED	1	41	53	49	49	54	55	51	50	60
	2	41	53	49	49	54	55	51	50	60
	3	52	54	52	51	53	52	48	45	61

ILHT/4-400 MV 0,55kW

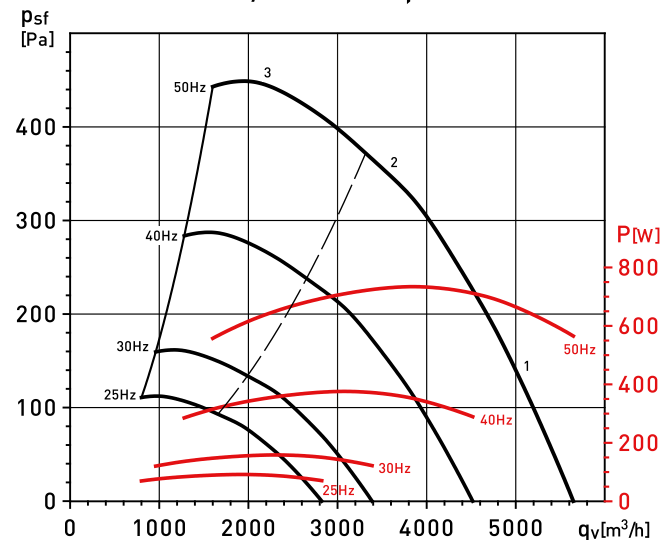

ILHT/4-400		63	125	250	500	1000	2000	4000	8000	LwA
INLET	1	46	76	72	66	70	72	68	65	80
	2	43	73	68	64	68	69	65	60	77
	3	54	72	69	65	67	67	63	58	76
OUTLET	1	48	71	73	73	75	74	70	64	81
	2	44	68	70	69	72	70	67	60	77
	3	55	70	72	70	72	68	62	55	78
RADIATED	1	43	63	61	56	59	59	54	48	68
	2	40	59	57	53	57	57	52	43	64
	3	51	59	58	55	56	54	49	42	64

PERFORMANCE CURVES

- q_v : Airflow in m^3/h and m^3/s .
- p_{sf} : Static pressure in mmWG and Pa.
- Dry air at 20°C and 760 mmHg.
- Performance data in accordance with ISO 5801 and AMCA 210-99 Standards.

ILHT/4-450 MV 1,1kW

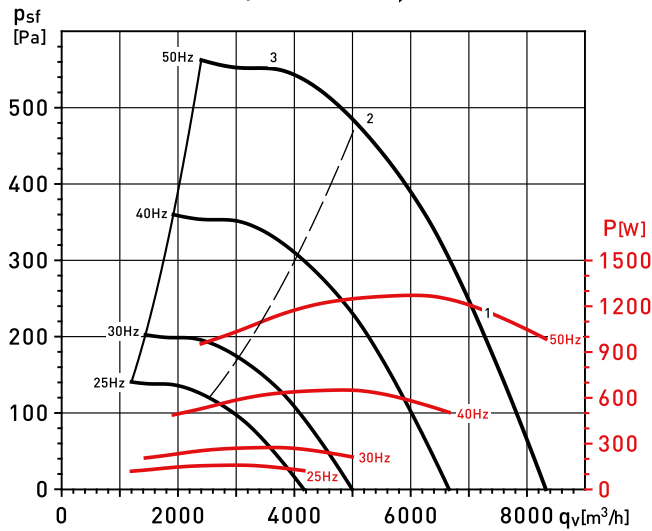

ILHT/4-450		63	125	250	500	1000	2000	4000	8000	LwA
INLET	1	53	77	74	70	76	75	72	67	82
	2	51	75	71	69	74	73	70	65	80
	3	62	75	73	70	73	70	66	61	80
OUTLET	1	53	76	78	76	78	77	74	69	85
	2	50	73	74	74	76	75	71	66	82
	3	58	73	76	75	76	72	67	61	82
RADIATED	1	50	68	62	59	64	64	62	53	72
	2	49	65	59	58	62	62	60	51	70
	3	59	66	61	59	62	59	56	47	70

ILHT/4-500 MV 1,5kW

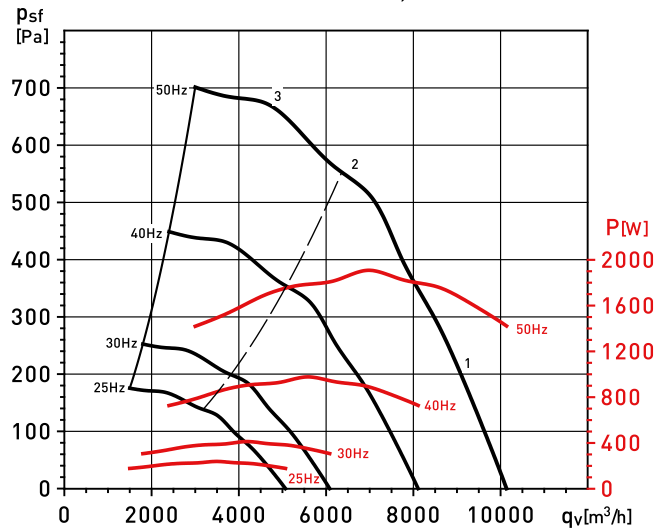

ILHT/4-500		63	125	250	500	1000	2000	4000	8000	LwA
INLET	1	58	74	73	73	78	77	75	70	83
	2	54	75	70	70	78	76	73	72	82
	3	57	75	71	71	76	74	73	70	82
OUTLET	1	59	77	80	78	81	78	76	71	87
	2	56	75	76	75	80	77	74	70	84
	3	60	76	77	76	79	75	71	67	84
RADIATED	1	50	65	65	63	67	66	65	59	73
	2	46	65	62	60	67	65	62	61	72
	3	49	66	63	61	66	63	63	58	72

ILHT/4-560 MV 2,2kW

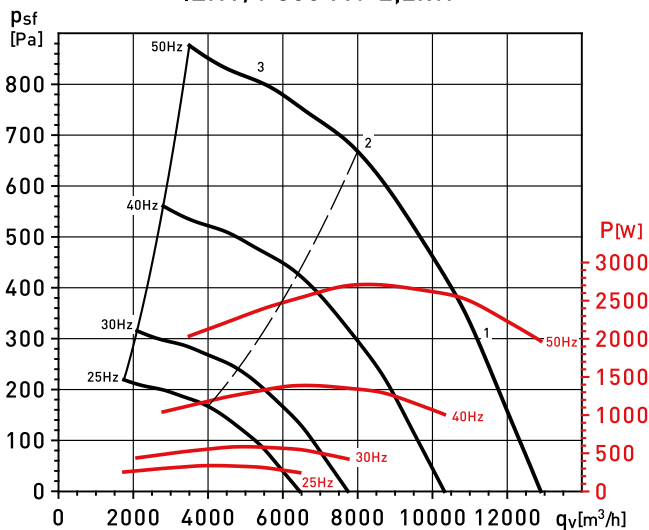

ILHT/4-560		63	125	250	500	1000	2000	4000	8000	LwA
INLET	1	58	76	75	73	80	78	75	69	85
	2	57	73	72	74	79	77	73	67	83
	3	63	79	75	74	78	74	70	65	84
OUTLET	1	60	81	82	80	83	80	78	73	89
	2	59	79	79	77	82	79	76	70	87
	3	63	79	80	78	81	77	73	67	86
RADIATED	1	47	66	67	64	69	66	62	55	74
	2	46	62	64	64	68	65	60	53	73
	3	52	68	67	65	67	62	57	51	73

PERFORMANCE CURVES

- q_v : Airflow in m^3/h and m^3/s .
- p_{st} : Static pressure in mmWG and Pa.
- Dry air at 20°C and 760 mmHg.
- Performance data in accordance with ISO 5801 and AMCA 210-99 Standards.

ILHT/6-355 MV 0,18kW

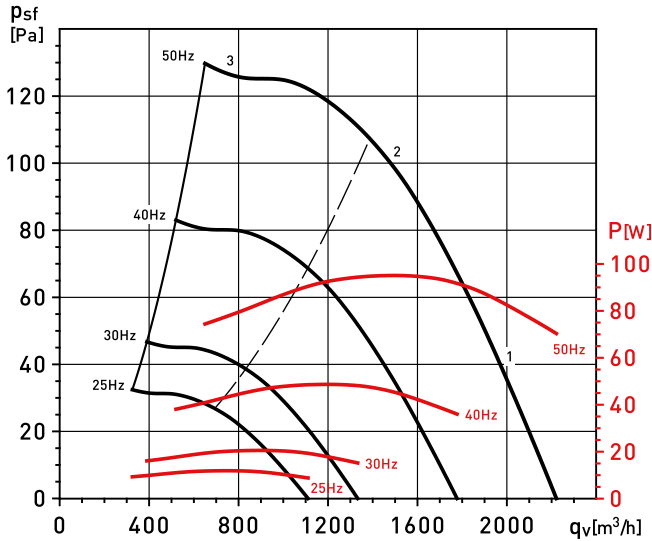

ILHT/6-355		63	125	250	500	1000	2000	4000	8000	LwA
INLET	1	33	59	56	52	57	59	55	50	65
	2	32	56	53	50	57	55	52	48	62
	3	43	57	56	52	56	52	48	44	63
OUTLET	1	33	58	60	58	60	60	56	50	67
	2	31	56	58	56	58	57	52	46	64
	3	42	57	59	58	57	55	48	42	64
RADIATED	1	34	46	44	43	46	49	46	43	54
	2	33	44	40	41	45	46	42	41	52
	3	43	45	44	43	44	43	39	37	52

ILHT/6-400 MV 0,37kW

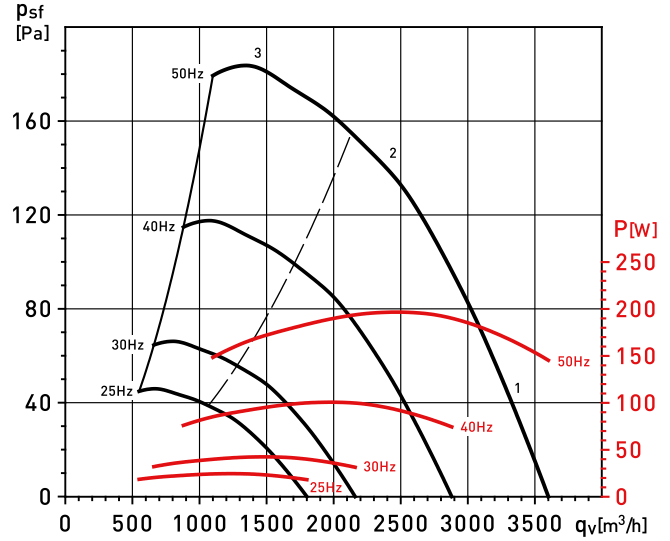

ILHT/6-400		63	125	250	500	1000	2000	4000	8000	LwA
INLET	1	37	68	64	58	61	63	59	56	71
	2	35	64	59	55	59	60	57	51	68
	3	45	63	61	56	59	58	54	50	67
OUTLET	1	39	62	65	64	66	65	62	56	72
	2	35	59	61	60	63	61	58	51	68
	3	46	61	63	61	63	59	53	46	69
RADIATED	1	34	54	52	47	50	51	45	39	59
	2	31	51	48	44	48	48	43	34	56
	3	42	50	49	46	48	46	40	33	55

ILHT/6-450 MV 0,37kW

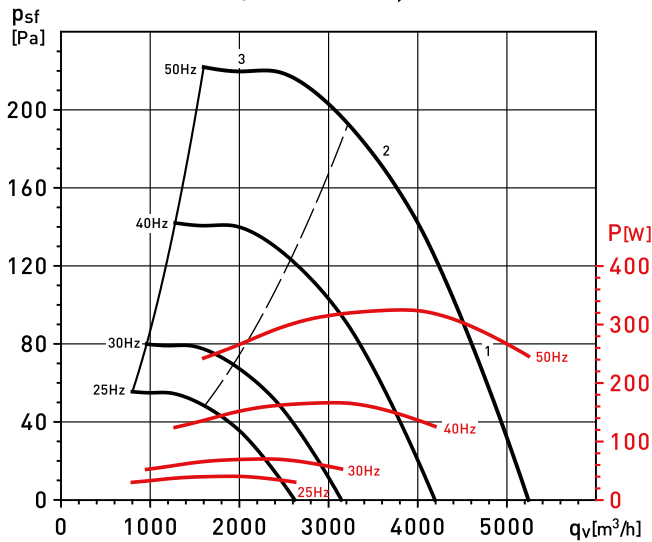

ILHT/6-450		63	125	250	500	1000	2000	4000	8000	LwA
INLET	1	44	68	65	61	67	66	63	58	74
	2	42	66	62	60	65	64	61	56	71
	3	53	66	64	62	64	61	57	52	71
OUTLET	1	44	67	69	68	70	68	65	60	76
	2	41	65	65	65	67	66	62	57	73
	3	49	65	67	66	67	63	58	52	73
RADIATED	1	41	59	54	50	55	55	53	44	63
	2	40	57	51	49	54	53	51	42	61
	3	50	57	52	50	53	50	47	38	61

ILHT/6-500 MV 0,55kW

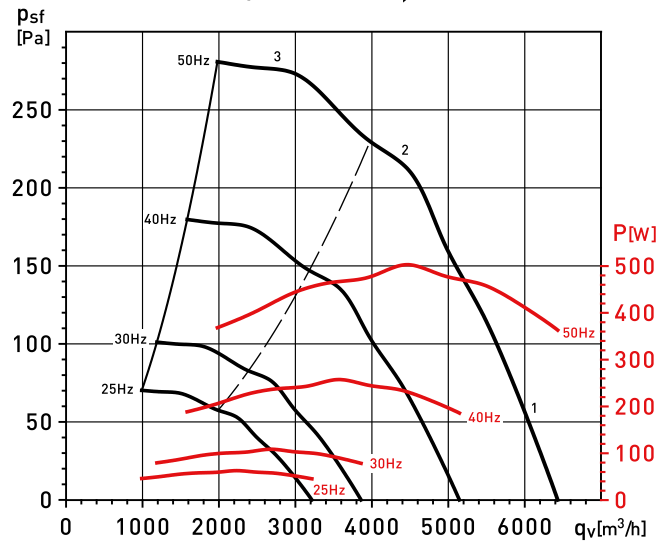

ILHT/6-500		63	125	250	500	1000	2000	4000	8000	LwA
INLET	1	49	65	64	64	69	69	66	61	75
	2	45	66	61	61	69	67	64	63	74
	3	48	66	62	62	68	66	64	61	73
OUTLET	1	50	69	71	69	73	70	67	62	78
	2	47	67	67	66	71	68	65	61	76
	3	51	67	69	67	70	66	62	58	75
RADIATED	1	41	56	56	54	59	58	56	50	65
	2	37	56	53	52	58	56	54	52	63
	3	40	57	54	52	57	55	54	50	63

PERFORMANCE CURVES

- q_v : Airflow in m^3/h and m^3/s .
- p_{st} : Static pressure in mmWG and Pa.
- Dry air at 20°C and 760 mmHg.
- Performance data in accordance with ISO 5801 and AMCA 210-99 Standards.

ILHT/6-560 MV 0,75kW

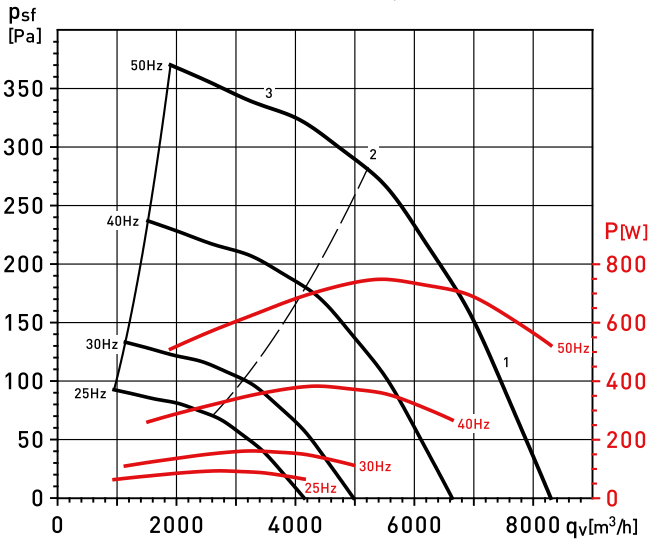

ILHT/6-560		63	125	250	500	1000	2000	4000	8000	LwA
INLET	1	49	68	66	64	71	70	66	61	76
	2	48	64	63	65	70	69	64	59	75
	3	55	70	66	65	69	66	61	57	75
OUTLET	1	51	72	73	71	74	71	69	64	80
	2	50	70	70	69	73	70	67	61	78
	3	54	70	71	69	72	68	64	58	78
RADIATED	1	38	57	59	55	60	58	53	46	65
	2	37	53	56	56	59	57	51	44	64
	3	43	59	58	56	58	54	48	42	65

ILHT/6-630 MV 1,5kW

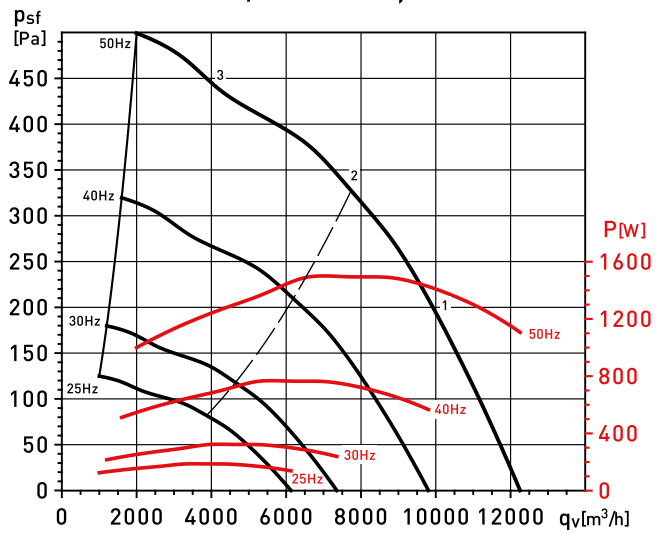

ILHT/6-630		63	125	250	500	1000	2000	4000	8000	LwA
INLET	1	54	72	69	68	74	73	68	63	79
	2	56	69	68	68	74	71	68	67	78
	3	63	70	70	68	71	67	63	63	77
OUTLET	1	56	70	73	74	77	73	69	63	81
	2	56	68	71	72	76	71	66	61	80
	3	62	69	74	74	75	68	63	61	80
RADIATED	1	45	61	61	61	64	64	61	59	70
	2	48	58	60	60	64	63	61	63	70
	3	54	60	61	60	61	58	56	59	68

ILHT/6-710 MV 3kW

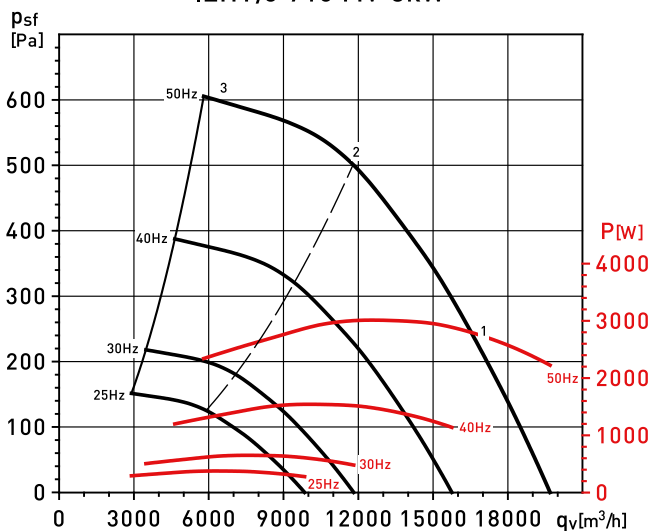

ILHT/6-710		63	125	250	500	1000	2000	4000	8000	LwA
INLET	1	59	76	72	77	80	77	71	66	84
	2	65	76	75	77	76	72	66	62	83
	3	69	75	73	77	76	73	68	63	82
OUTLET	1	67	78	81	84	83	79	73	69	89
	2	62	74	79	83	81	76	71	68	87
	3	68	74	80	83	80	74	70	68	87
RADIATED	1	54	71	66	73	75	71	66	61	79
	2	59	71	69	73	71	65	62	58	78
	3	63	69	67	73	71	66	63	59	78

ILHT/6-800 MV 4kW

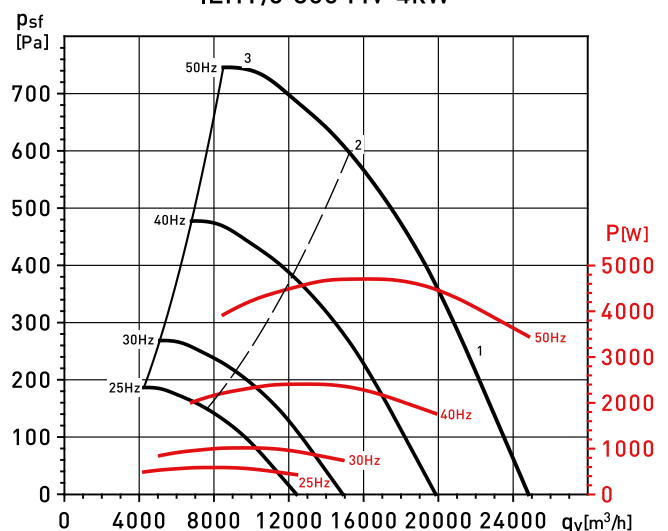

ILHT/6-800		63	125	250	500	1000	2000	4000	8000	LwA
INLET	1	60	76	74	76	81	79	73	68	86
	2	61	73	73	76	81	77	72	70	85
	3	71	78	76	76	79	74	72	68	84
OUTLET	1	63	79	80	82	82	80	73	69	88
	2	63	78	78	80	81	77	72	71	87
	3	69	78	79	80	80	76	72	69	86
RADIATED	1	55	72	68	67	74	73	68	71	80
	2	56	69	67	66	74	71	67	73	79
	3	67	74	70	67	71	68	67	71	79

MOUNTING ACCESSORIES

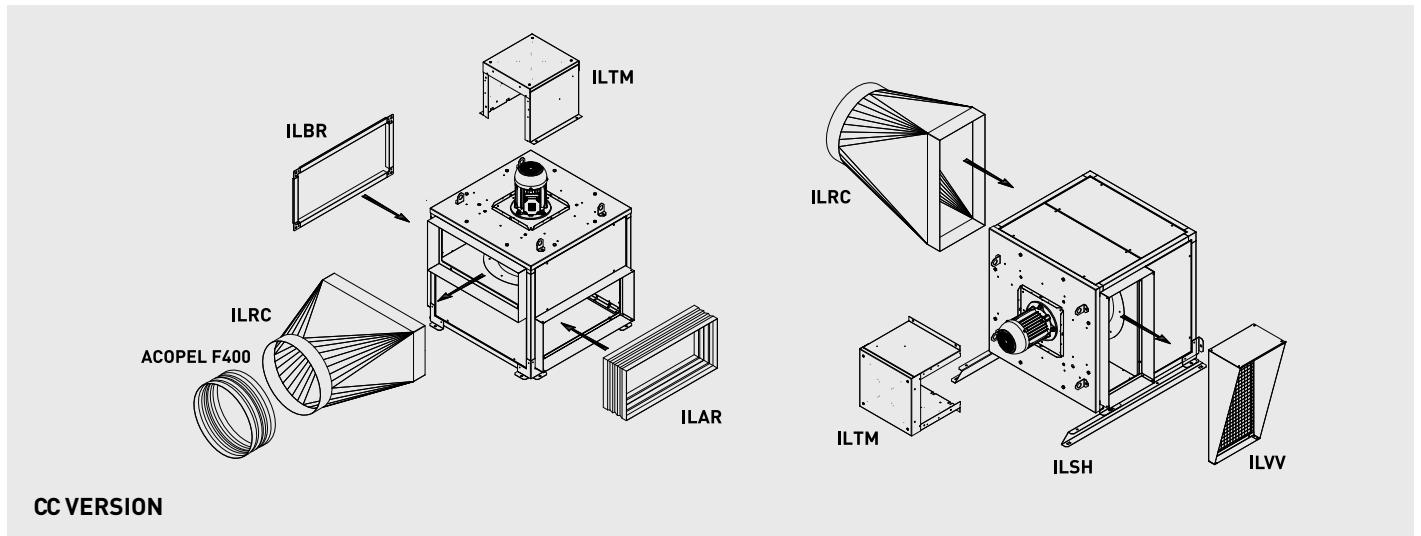

CC VERSION

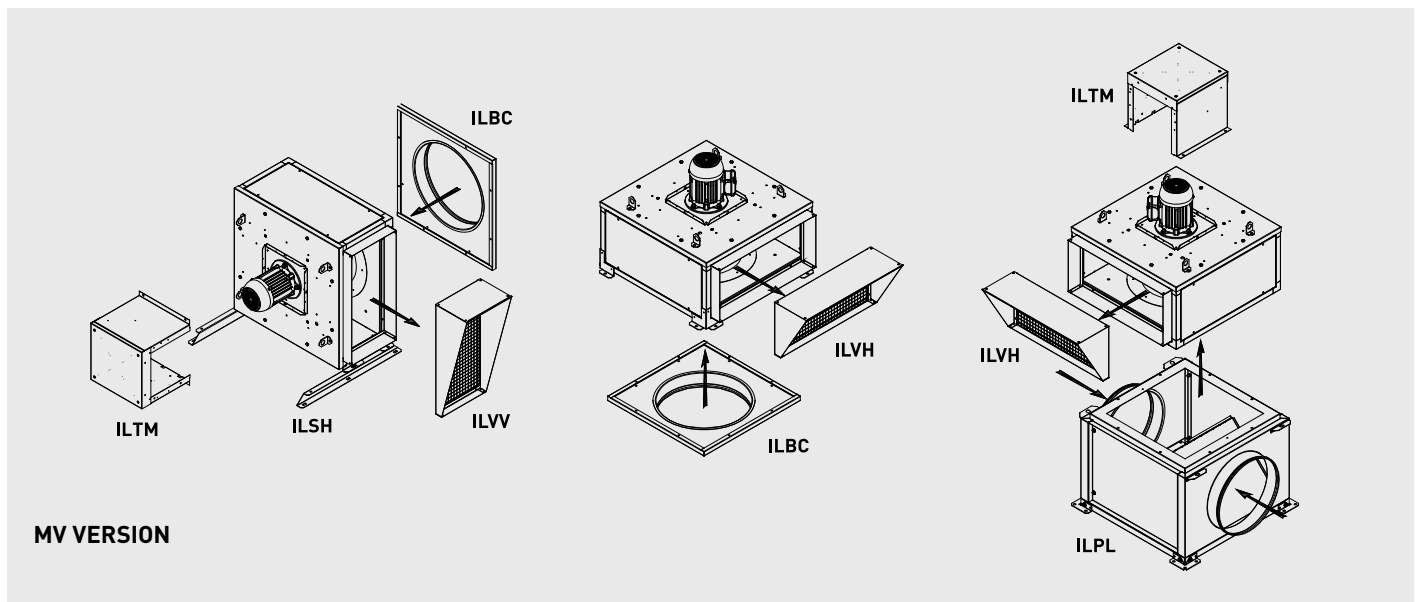

MV VERSION

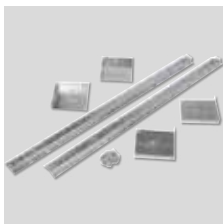

ILSH
 Mounting support with motor in horizontal position



ILBR
 Rectangular duct connection flange

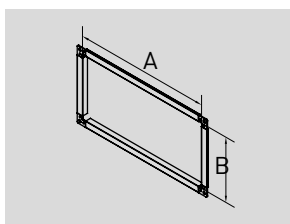

Model	A	B
355	559	263
400	631	297
450	711	326
500	768	338
560	864	354
630	977	403
710	1104	462
800	1248	488

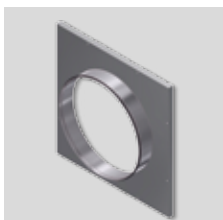

ILBC
 Inlet circular duct connection flange (MV version)

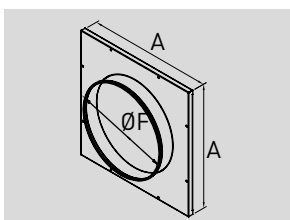

Model	A	F
355	559	400
400	631	450
450	711	500
500	768	560
560	864	63
630	977	710
710	1104	800
800	1248	900

IN-LINE CENTRIFUGAL DUCT FANS ILHB-ILHT Series



ILTM
Motor cover

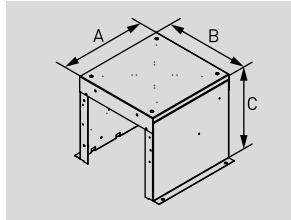

Model	A	B	C
355	340	325	305
400	340	325	305
450	340	325	305
500	415	475	355
560	415	475	355
630	415	475	355
710	510	465	450
800	510	465	450



ILRC
Outlet circular duct connection flange

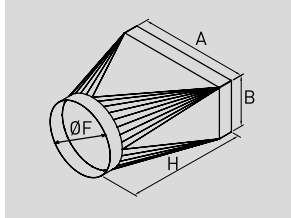

Model	A	B	F	H
355	559	266	400	670
400	631	300	450	670
450	711	329	500	670
500	768	341	560	670
560	864	357	63	670
630	977	406	710	670
710	1104	465	800	670
800	1248	491	900	670



ILAR
Flexible rectangular flange duct connector.

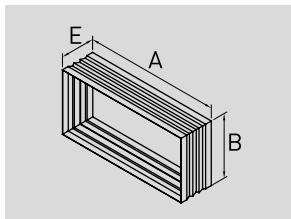

Model	A	B	E
355	559	266	160
400	631	300	160
450	711	329	160
500	768	341	160
560	864	357	160
630	977	406	160
710	1104	465	160
800	1248	491	160



ACOPEL F400 N
Circular flexible connector.
Certified F400-120.

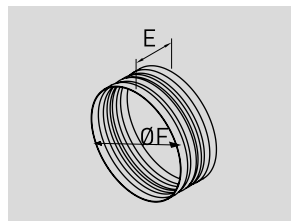

Model	E	F
355	160	400
400	160	450
450	160	500
500	160	560
560	160	63
630	160	710
710	160	800
800	160	900



ILVV - ILVH
Discharge protection guard

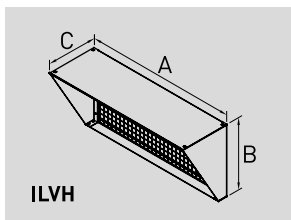

Model	A	B	C
355	559	263	197
400	631	297	216
450	711	326	233
500	768	338	240
560	864	354	250
630	977	403	278
710	1104	462	311
800	1248	488	328

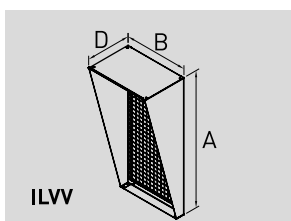

Model	A	B	D
355	559	263	194
400	631	297	213
450	711	326	234
500	768	338	249
560	864	354	275
630	977	403	305
710	1104	462	340
800	1248	488	378

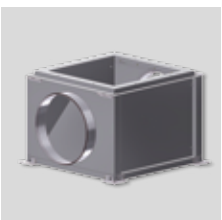

ILPL
Doble inlet plenum (MV version)

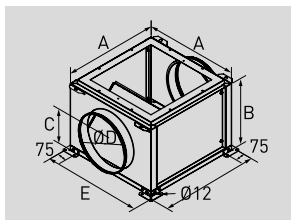

Model	A	B	C	D	E	kg
355	622	448	238	355	662	21
400	694	498	260	400	734	25
450	774	555	289	450	814	30
500	852	675	349	560	892	37
560	948	755	389	630	988	60
630	1060	805	441	630	1100	81
710	1188	885	481	710	1228	99



ISA-ILHT
Anti-vibrations support.
(Set of 4 rubber supports)

ELECTRICAL ACCESSORIES



REB
 Single phase electronic speed controller.



RMB/RMT
 Fan speed controllers by auto-transformer.



VAPZ
Electronic single phase regulator that controls the fan speed with a simple contact (presence detector) or an analogical input, 0-10 V or 4-20 mA (from CO₂ probe or relative sensor).



VRPZ
 Electronic control with display for single phase 230V-50/60Hz fans. Analogical input 0-10V or 4-20mA: Operating regulation, either with setting value or external signal (current or voltage)



VFKB IP65
 Adjustable frequency drives for three phase motors from 0,37 to 4 kW 230V or 400V.



VFTM IP21
 Adjustable frequency drive for three phase motors.



SC02-A
 CO₂ and temperature sensor

SC02-AD
 CO₂ and temperature sensor sensor, with display.

SCHT-AD
 CO₂ sensor, temperature and relative humidity 2 with display.



CPFL-S / CPFL-E
 Presence detector.



TDP-S/TDP-D/TDP-PI
 Pressure sensor.



ON/OFF electrical isolation switch